

00702002 P

DAMPFGARER

EDG6500M

EDG6500M1

H234KU121

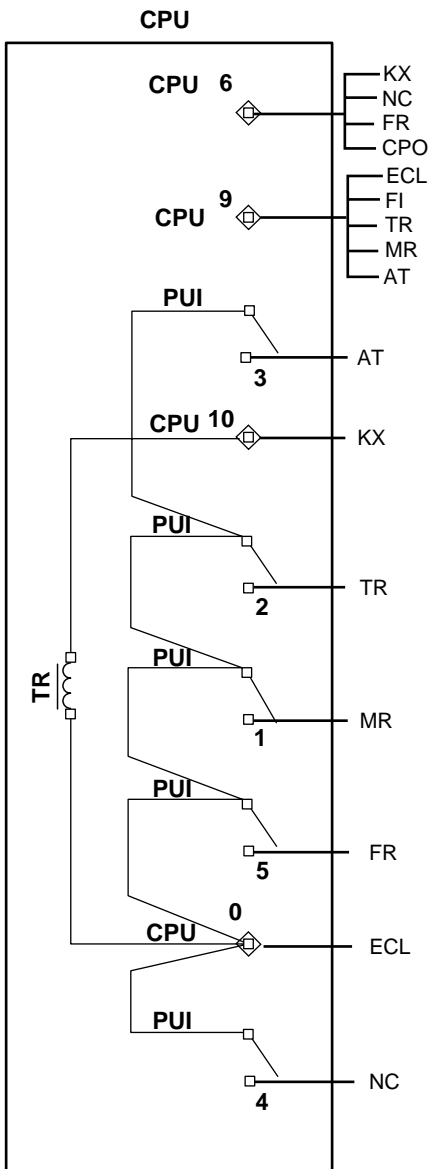
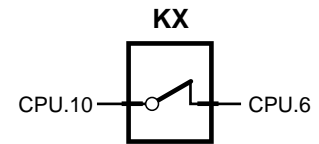
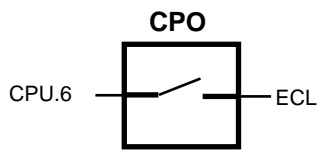
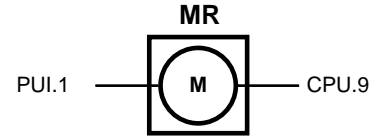
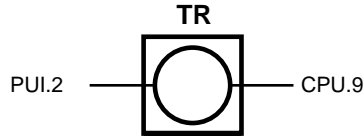
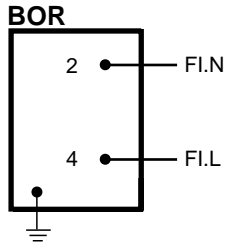

00702002 C

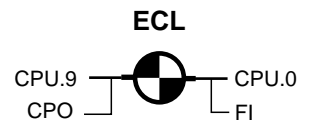
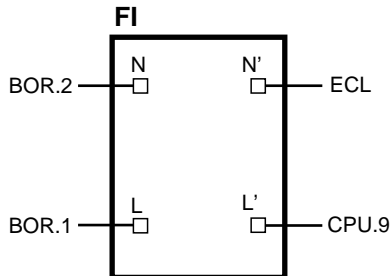

LEGENDE

- AT : THERMOELEK. AKTIVATOR
- BOR : SCHALTER
- CPU : STEUERKARTE
- CPO : MINISCHALTER
- ECL : LAMPE
- FI : ENTSTÖRUNGSFILTER
- FR : GENERATOR
- KX : KLIXON
- MR : TURBINE
- NC : HEIZSCHLANGE
- TR : MAGNETVENTIL

7X8405

03/2005
TA 2/2