

main switch

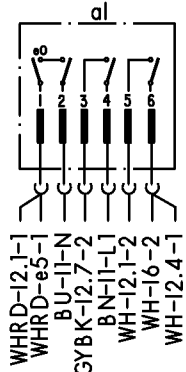

service and control module

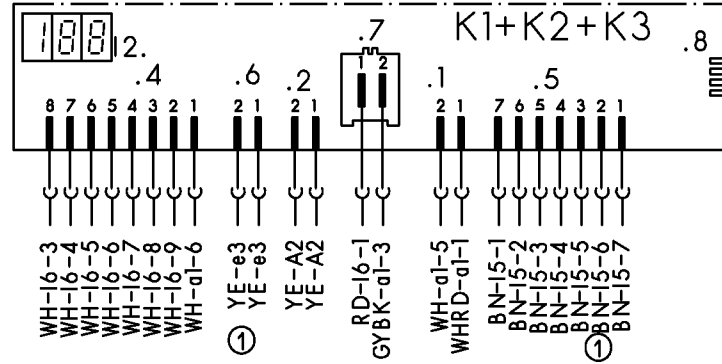

reed switch

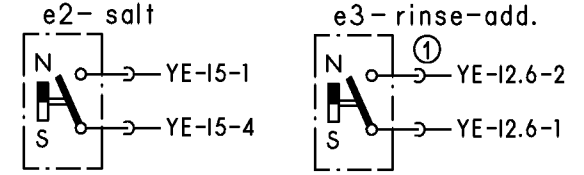

earth terminal

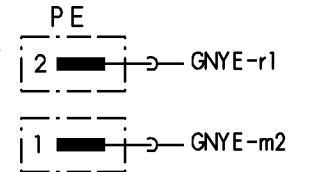

water points

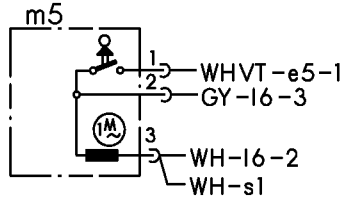

level switch

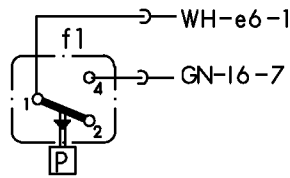

thermostat + NTC

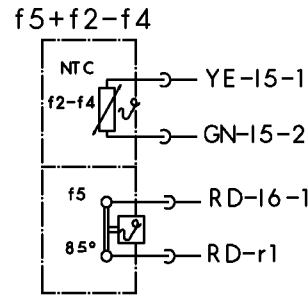

aktuator

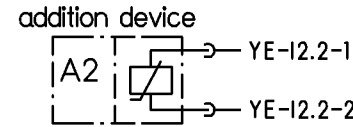

aqua-sensor

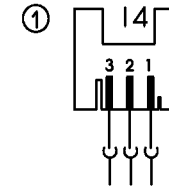

clutch

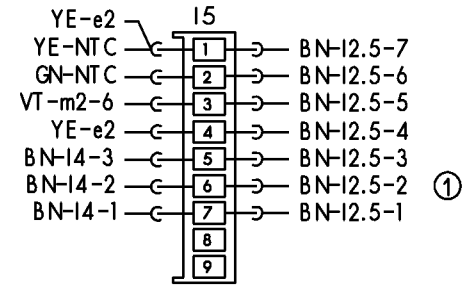

float switch

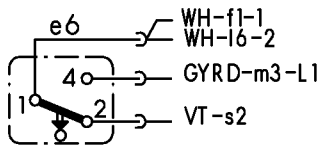

solenoid valves

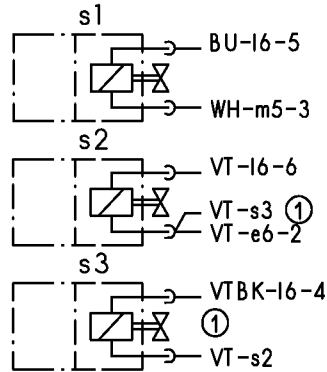

safety switch

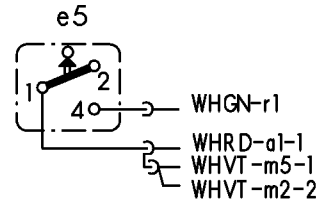

motor

starting Relais

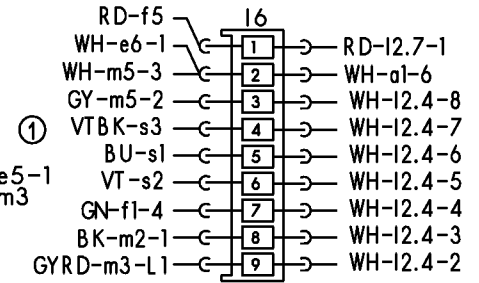
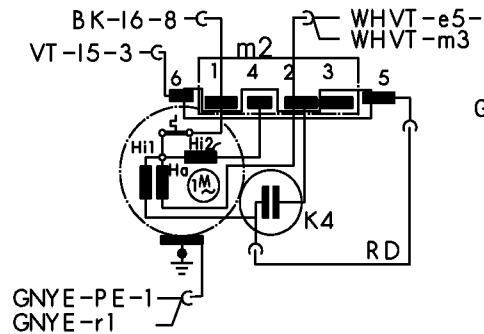

terminal I1 with interference suppression

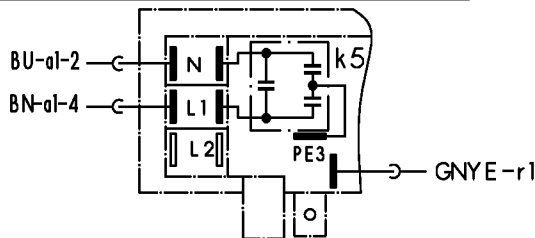

heating

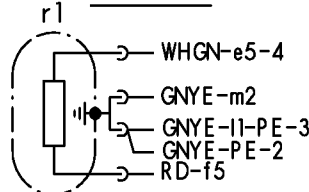

drain pump

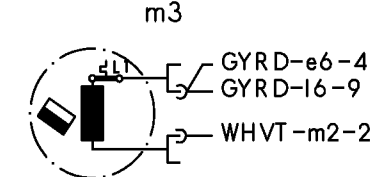

① exist according to equipment

GB

Mat.Nr.: 5600048897	
Ausg.: 04.02	S0-60/0655

MODUL K1 + K2 + K3

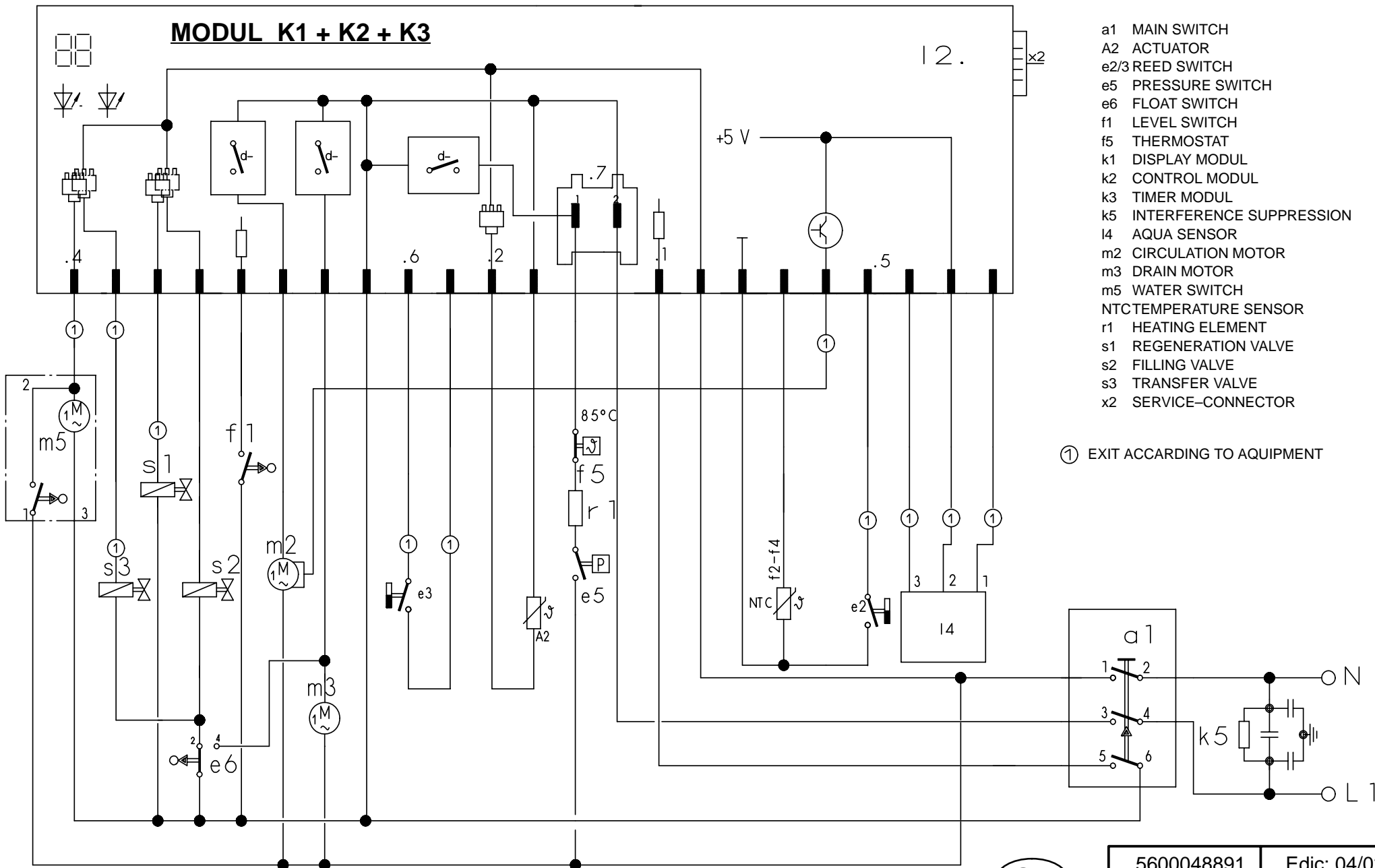

- a1 MAIN SWITCH
- A2 ACTUATOR
- e2/3 REED SWITCH
- e5 PRESSURE SWITCH
- e6 FLOAT SWITCH
- f1 LEVEL SWITCH
- f5 THERMOSTAT
- k1 DISPLAY MODUL
- k2 CONTROL MODUL
- k3 TIMER MODUL
- k5 INTERFERENCE SUPPRESSION
- I4 AQUA SENSOR
- m2 CIRCULATION MOTOR
- m3 DRAIN MOTOR
- m5 WATER SWITCH
- NTC TEMPERATURE SENSOR
- r1 HEATING ELEMENT
- s1 REGENERATION VALVE
- s2 FILLING VALVE
- s3 TRANSFER VALVE
- x2 SERVICE-CONNECTOR

① EXIT ACCORDING TO EQUIPMENT

GB

5600048891	Edic: 04/02
	S0-60/0654

Coding instructions

After replacing the electronic controls (standard installation), the control must be recoded with the appliance programmes (see table).

Note: In the case of appliances with 3 programmes/buttons the control must be programmed before the control panel frame is attached.

1. Selection:

Simultaneously press and hold down the S2, S3, S4 and S5 buttons and press the main switch. As long as the S2 to S5 buttons remain depressed, the L2 to L5 LEDs flash.

When the S2 to S5 buttons are released, the current coding is displayed binary coded via the L2, L3 and L4 LEDs (see code table).

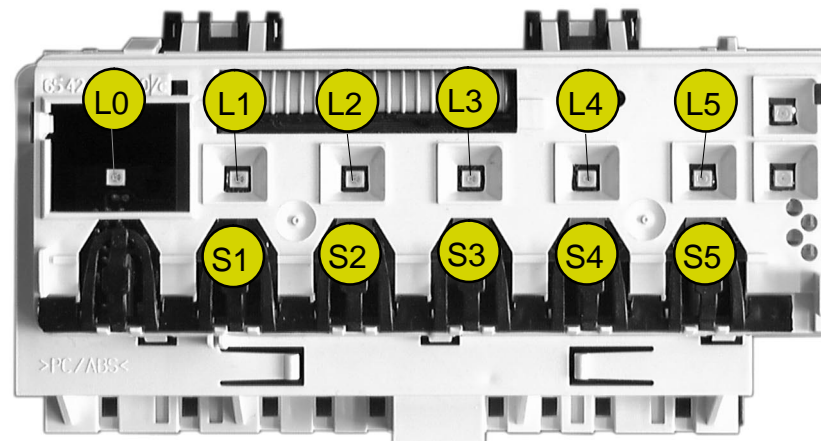

2. Selecting the model:

The various codings can be selected by pressing the S2 button (see table).

3. Storing the coding:

The new coding is stored by switching off the appliance.

Code table:

Coding	Button					Display		
	S1	S2	S3	S4	S5	LED L2	LED L3	LED L4
0	---	---	---	---	---	○	○	○
1	---	Normal 65°	ECO 50°	Quick wash 35°	Pre-rinse	⊗	○	○
2	---	Normal 65°	ECO 50°	Vorspülen		○	⊗	○
3	Intensive 70°	Normal 65°	ECO 50°	Quick wash 35°	Pre-rinse	⊗	⊗	○
4						○	○	⊗

LED off ○

LED illuminates ⊗

Programme symbols:



Intensive 70°



Quick wash 35°



Normal 65°



Gentle 40°



ECO 50°



Pre-rinse



5600.045.163	Ausg.: 08.01
H_WW; GV450/630	S0-60/0608

Customer service test programme

1. Selection:

Switch off the appliance and close the door.
Hold down buttons S2 and S4 and press the main switch.

The following displays are indicated on the fascia:

- LEDs L2 and L4 flash
- As long as the two buttons S2 and S4 remain depressed after the appliance was switched on, the model code is displayed in binary via L2, L3 and L4.
(e.g. L2 always on = model 1, L2 + L3 always on = model 3)
- When one of the buttons is pressed, the associated LED lights up.
- When button S3 is pressed, the refill indicators and the End LED illuminate.

The designation of the buttons and LEDs refers to the electronics module and not to the fascia.

2.Start:

Press buttons S2 and S4 again to start the test programme.

While the test programme is running, press button S3 to move to the next programme step.
(Exception: Move to the next filling step by pressing filling switch F1 only)

3.Fault display:

Potential faults are displayed via the programme LEDs:

L2 always on = Heater fault

L3 always on = Filling fault

L4 always on = NTC fault

L5 always on = Water points fault (only visible without panel box on appliances with 3 programmes!!!)

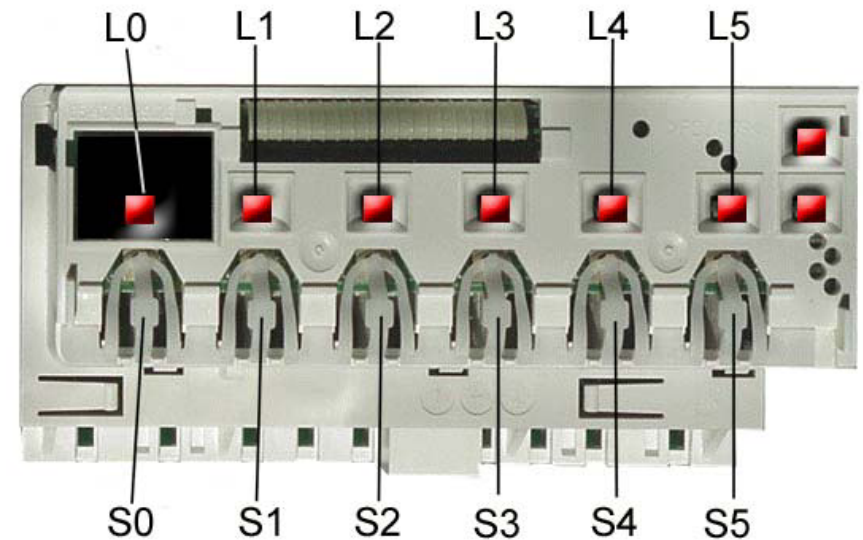

5600 051 469	Ausg.: 01.03
H,WE,GV450	S0-60/0737 2/1

4. Sequence of the customer service test programme:

	Function	Temperature	Capacity	Time (s)	Sensor	Symbol
0	P			15		P = Pump
1	VF				F1	VF = Prefill
2	F		3.9 l			F = Fill (timed refilling)
3	U + H + ZR	max. 72°C		120		U = Circulate
4	U + H	60°C				H = Heat
5	U + H + R	max. 72°C		120		ZR = Dispense detergent
6	U + H + ZK	max. 72°C		120		ZK = Dispense rinse aid
7	WP			35		R = Regeneration valve
8	P			45		FWW = Fill soft water
9	FWW			60		WP = Alternating pumping
10	P			5		PA = Pause
11	PA			5		
12	P			5		
13	PA			5		
14	P			5		
15	PA			5		
16	P			30		

5. End the test programme:

End the test programme by switching off the appliance via the main switch.

5600 051 469	Ausg.: 01.03
H,WE,GV450	S0-60/0737 2/2