

main switch

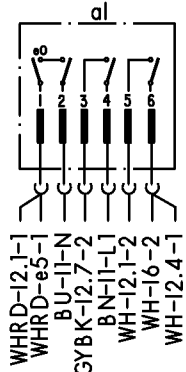

service and control module

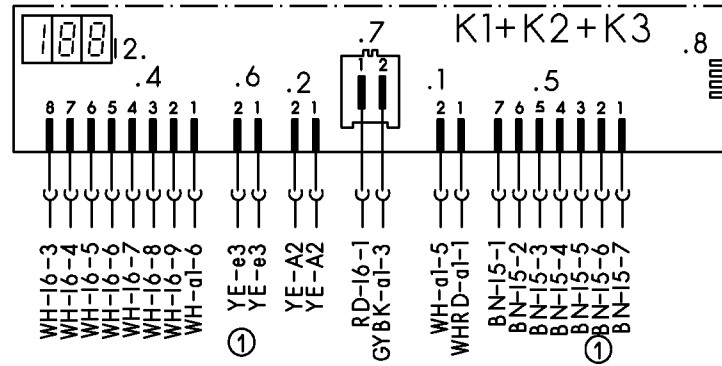

reed switch

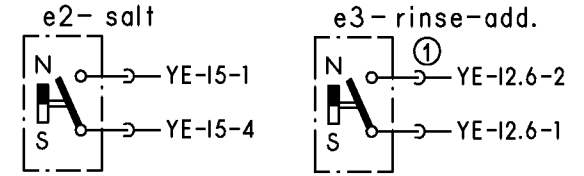

earth terminal

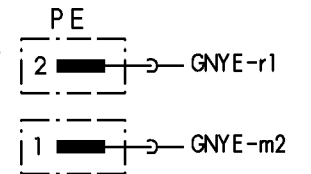

water points

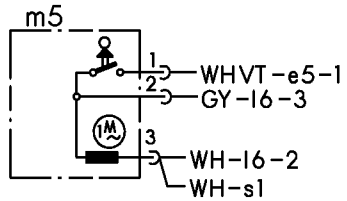

level switch

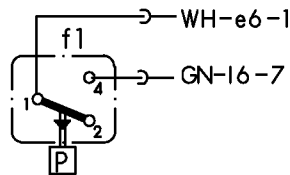

thermostat + NTC

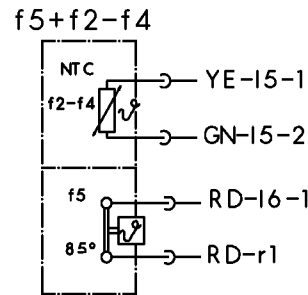

aktuator

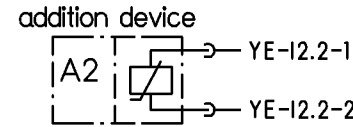

clutch

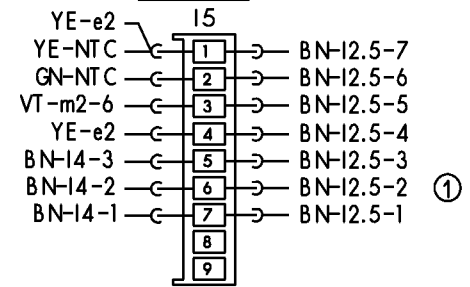

float switch

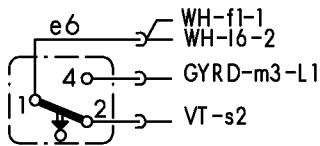

solenoid valves

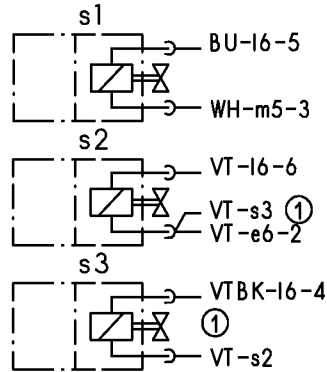

safety switch

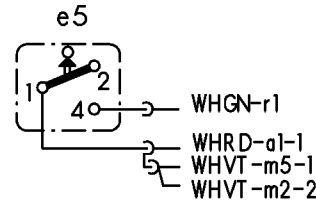

motor

starting Relais

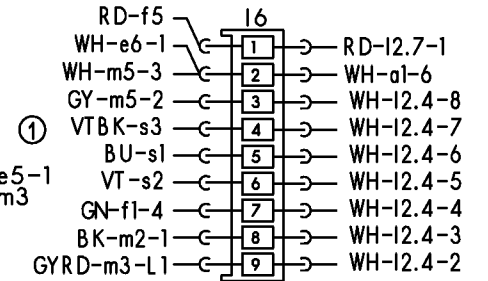
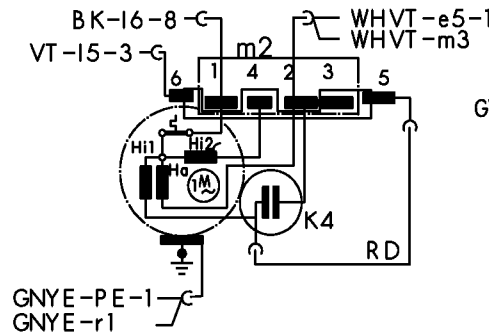

terminal 11 with interference suppression

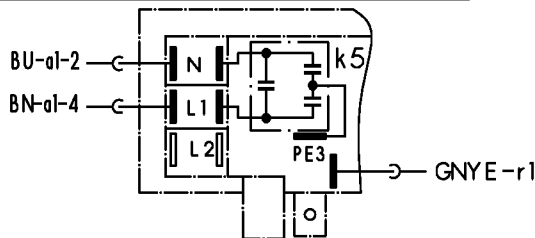

heating

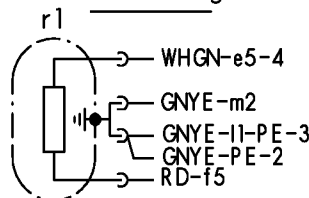

drain pump

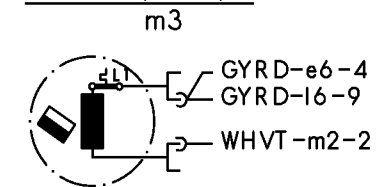

① exist according to equipment

GB

Mat.Nr.: 5600048897	
Ausg.: 04.02	S0-60/0655

MODUL K1 + K2 + K3

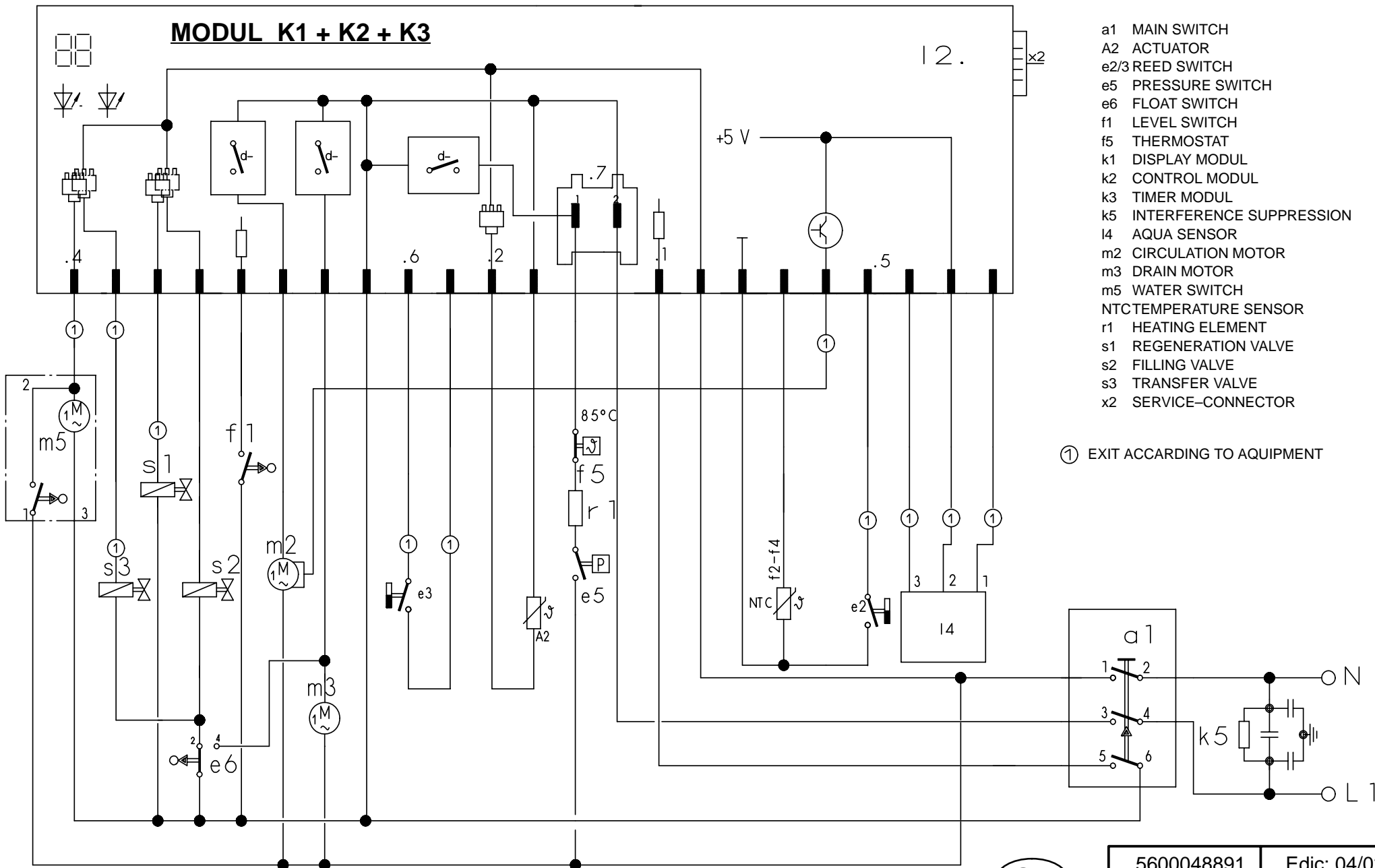

- a1 MAIN SWITCH
- A2 ACTUATOR
- e2/3 REED SWITCH
- e5 PRESSURE SWITCH
- e6 FLOAT SWITCH
- f1 LEVEL SWITCH
- f5 THERMOSTAT
- k1 DISPLAY MODUL
- k2 CONTROL MODUL
- k3 TIMER MODUL
- k5 INTERFERENCE SUPPRESSION
- i4 AQUA SENSOR
- m2 CIRCULATION MOTOR
- m3 DRAIN MOTOR
- m5 WATER SWITCH
- NTC TEMPERATURE SENSOR
- r1 HEATING ELEMENT
- s1 REGENERATION VALVE
- s2 FILLING VALVE
- s3 TRANSFER VALVE
- x2 SERVICE-CONNECTOR

① EXIT ACCORDING TO EQUIPMENT

GB

5600048891	Edic: 04/02
	S0-60/0654

Coding instructions

After replacing the electronic controls (standard installation), the control must be recoded with the appliance programmes (see table).

Note: In the case of appliances with 3 or 4 programmes/buttons the control must be programmed before the control panel frame is attached.

1. Selection:

Simultaneously press and hold down the S2, S3, S4 and S5 buttons and press the main switch. As long as the S2 to S5 buttons remain depressed, the L2 to L5 LEDs flash.

When the S2 to S5 buttons are released, the current coding is displayed (see code table).

2. Selecting the model:

The various codings can be selected by pressing the S2 button (see table).

3. Storing the coding:



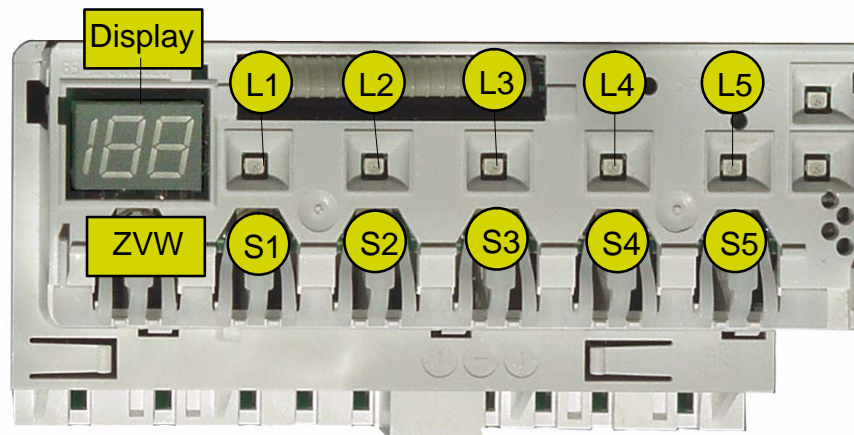



The new coding is stored by switching off the appliance.



Code table:

S0	S1	S2	S3	S4	S5	Display
ZVW	auto 55/65° Normal 65°	ECO 50°	Quick wash 35°	Pre-rinse		26
ZVW	Intensive 70°	auto 55/65°	ECO 50°	Quick wash 35°	Pre-rinse	27
ZVW	OK	auto 55/65°	ECO 50°	Quick wash 35°	Pre-rinse	28
ZVW	auto 55/65°	ECO 50°	Gentle 40°	Quick wash 35°		29

Programm-Symbole:

	Intensive 70°		Quick wash 35°		Upper rack washing (OK)
	auto 55/65°		Gentle 40°		Time preselection (ZVW)
	ECO 50°		Pre-rinse		



5600 044 492	Issued: 07.02
G; WE; WW; GV630/450	S0-60/0596

Customer service test programme

Function	Temperature	Capacity	Time (s)	Sensor	Symbol
1	P		15		P = Drain
2	VF			F1	VF = Prefill / static
3	PA		5		F = Fill / dynamic
4	F	3,9L			U = Circulate
4	U + H + ZR	max. 72 °C	120		U = Circulate
5	U + H	60 °C			H = Heat
6	U + H + R	max. 72 °C	120		ZR = Dispense detergents
7	U + H + ZK	max. 72 °C	120		ZK = Dispense rinse aid
8	AS_KAL_IR				R = Regenerate
9	WP		35		FWW = Fill with soft water
10	P		45		AWT = Heat-exchanger outlet valve
11	FWW + AWT		60		AS_KAL_IR = Calibrate turbidity sensor
12	SP		35		WP = Alternate Drain
13	P		30		SP = Intermittent pumping

Selecting the programme:

- Switch off the appliance
- Press and hold down buttons S2 and S4
- Switch on the main switch

The following displays are indicated on the control panel:

- LEDs L2 and L4 flash.
- For as long as the two buttons S2 and S4 are held down after the appliance has been switched on, an identifier for the version coding is displayed following a successful overtravel contact scan.
- If one of the buttons is pressed, the associated LED lights up.
- If button S3 is pressed, the display and the refill indicator LEDs also light up.
- If the preselected starting time button is pressed, an 18h illuminates in the segment display.

Starting the programme:

- Press buttons S2 and S4 again.

If button S1 is pressed during alternate rinsing, the water points remain in the top basket position the next time the water points change (within 60 s). LED L1 illuminates for as long as the top basket function has been selected. Preselected starting time is not possible. The test programme is ended by switching off the appliance via the main switch.

The following fault codes can be displayed:

Fault code	Description
0	There is no fault
1	Fault with the Aqua sensor system Note: Display even if there is no sensor!
2	Heating fault
4	Filling fault
8	Fault with the NTC system
16	Water points

If more than one fault is identified, the fault codes are added together (e.g.: fault code 3 = fault code 1 + fault code 2)

The next programme step can be actuated by pressing button S3.

(Exception: advance from the filling step by pressing the filling switch F1 only)

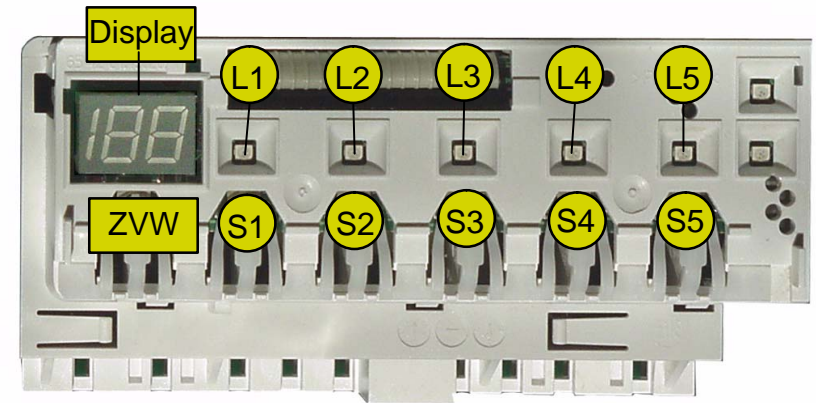

5600 057 141	Ausg.: 07.03
G; WE; WW; GV630, GV450	S0-60/0700