

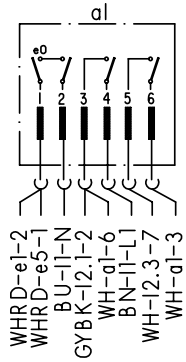

### main switch

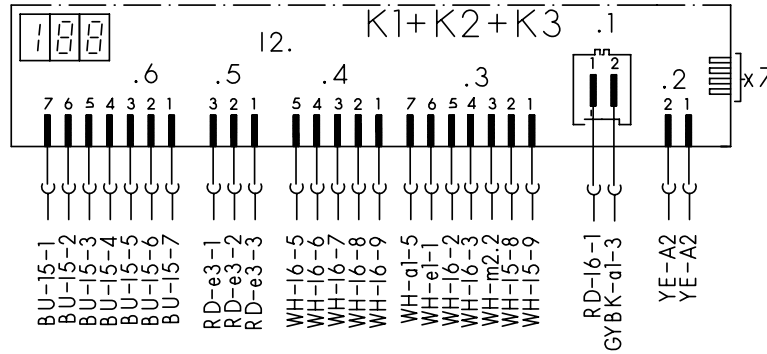

### on-off and selector switch



### reed switch

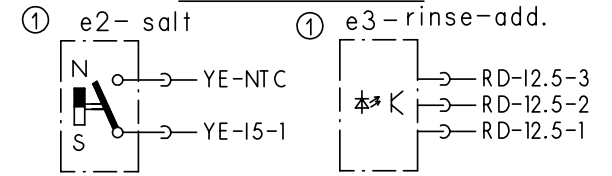

### earth terminal

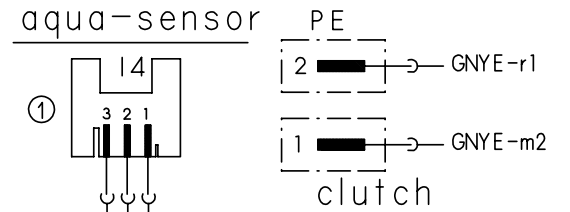

### level switch

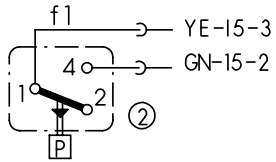

### flow meter

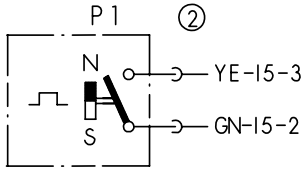

### thermostat + NTC

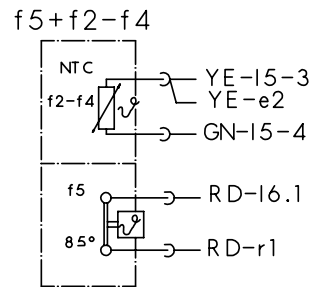

### aktuator

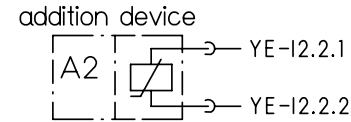

### water switch

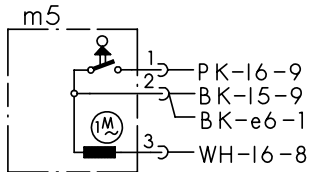

### solenoid valves

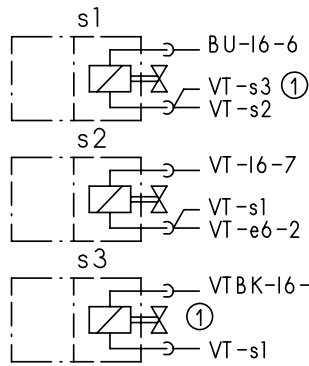

### float switch

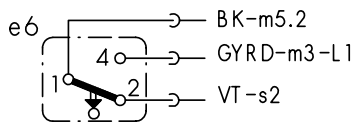

### door switch

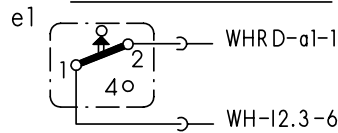

### safety switch

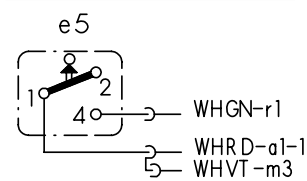

### motor

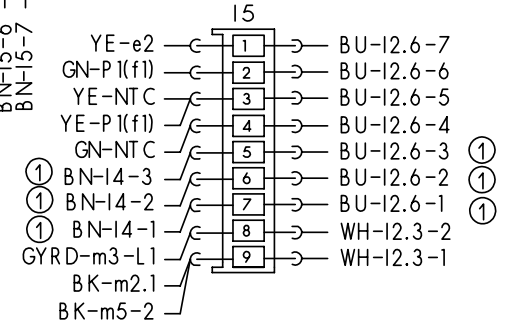
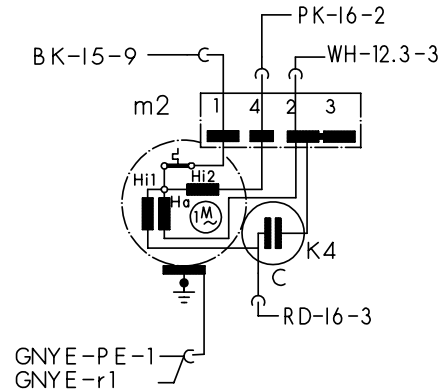

### terminal 11 with

### interference suppression

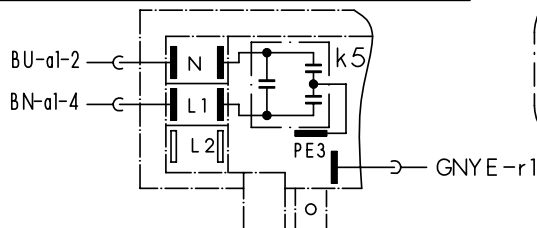

### heating

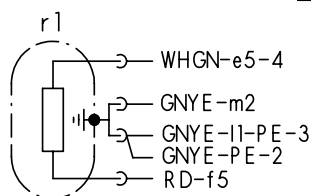

- ① exist according to equipment
- ② exist according to version

### drain pump

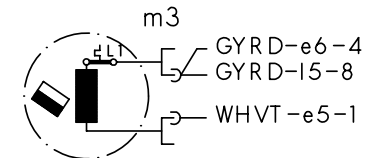

Mat.Nr.: 9000000820	
Ausg.: 12.03	SO-60/0866

GB

# Customer service test programme

## 1. Selecting the model coding:

- Turn the rotary switch (S0) to position “5”.
- Press main switch and hold down for at least 3 sec.
- The current model coding is displayed via LEDs L1 – L3 for as long as the main switch is held down.

## 2. Reading out the fault memory:

- When the main switch is released, the special programme “P0” Read out fault memory is selected.
- After 5 sec. the fault memory of the last rinse cycle is displayed via LEDs L1 – L3.
- If **no** fault occurred in the last 8 rinse cycles, LEDs L2 and L3 flash slowly (0.5 Hz)

### Only control units with display:

- If **no** fault occurred in the last 8 rinse cycles, LEDs L2 and L3 flash slowly (0.5 Hz) and “E0” is displayed. **No** other fault memory can be read out.
- If a fault was detected, the fault memory of the last 8 rinse cycles can be read out by pressing and releasing one of the buttons S1 or S2. When the button is pressed, the rinse cycle is displayed and when the button is released, the associated fault (see table) is displayed.

## 3. Starting the customer service test programme

- Read out from the fault memory position, turn the rotary switch (S0) clockwise to position “6”
- The customer service test programme starts automatically
- LED L3 flashes during the customer service test programme
- The current position in the customer service test programme is displayed (only control units with display)
- Each change in state of the position switch for the water points is indicated by all LEDs lighting up briefly (function test of the LEDs and the position switch)
- A fault which has occurred is indicated immediately via the display or the LEDs L1 – L3 (heating fault after 60 minutes)
- If several faults occur, only the fault with the highest value is displayed
- Following each repair a customer service test programme must be run to detect any other faults.

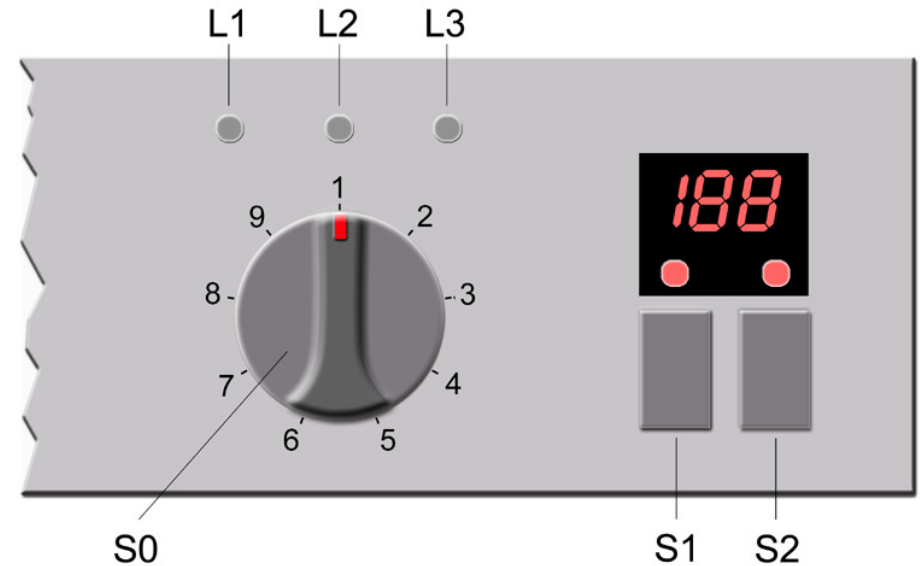

Document No. 56000000112804 ASP EN A	Rev. A	Sheet-No. 1 of 2
Material No. 9000 014 462	GV630, N / O, WE, DS	

**Fault code:**

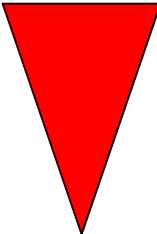
Fault code with display	Fault code without display			Fault type	Value
	L1	L2	L3		
E01	○	○	●	Heating fault	
E02	○	●	○	NTC fault	
E03	○	●	●	Filling fault	
E04	●	○	○	Water points cannot be positioned	
E05	●	○	●	---	
E06	●	●	○	Aqua sensor	
E07	●	●	●	---	

○ = LED off      ● = LED flashes quickly (2 Hz)

**Sequence of the customer service test programme:**

Pos.	Function	Temperature	Capacity	Time (s)	Symbol
00	P			15	P = Pump
01	FWW		1.5 l		FWW = Fill soft water
02	PA			5	U = Circulate
03	Reversal relay/auxiliary winding (SICASYM) + U + FWW		2.4 l	10 + X	H = Heat
04	U + H + ZR	max. 72 °C		120	ZR = Dispense detergent
05	U + H	60 °C			ZK = Dispense rinse aid
06	U + H + R	max. 72 °C		120	R = Regeneration valve
07	U + ZK			120	AS_KAL = Calibrate Aqua sensor
08	AS_KAL				WP = Alternating pump
09 - 14	WP			30	SP = Intermittent pump
15	P			45	X = Calculated refill time
16	FWW			60	
17-22	SP			30	
23	P			30	
0	End				

If the rotary switch (S0) is turned clockwise during the customer service programme, it is possible to jump to the next position.

The filling positions are an exception!

Document No. 56000000112804 ASP EN A	Rev. A	Sheet-No. 2 of 2
Material No. 9000 014 462	GV630, N / O, WE, DS	