

display

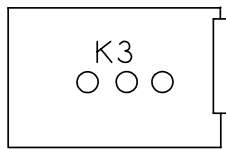

on-off and selector switch

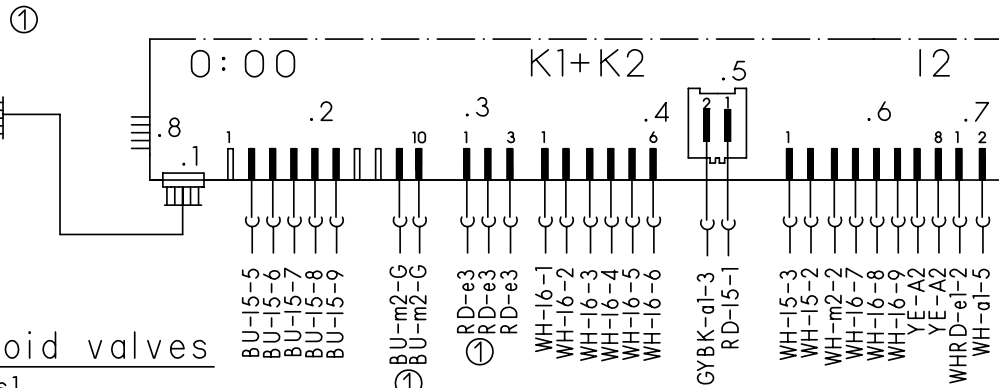

sensor

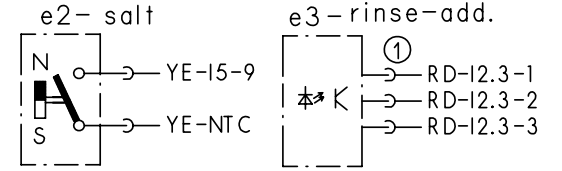

main switch

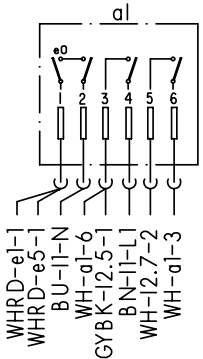

solenoid valves

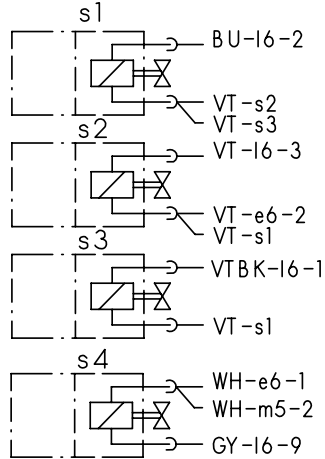

thermostat + NTC

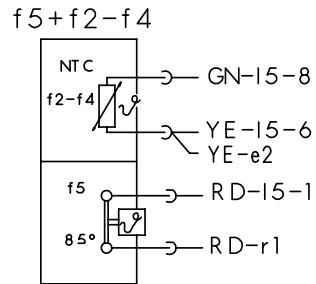

aqua-sensor

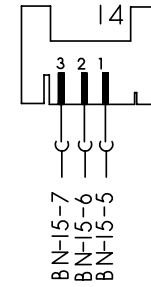

earth terminal

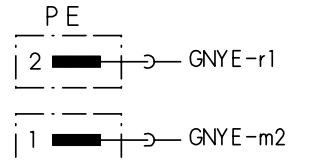

water points

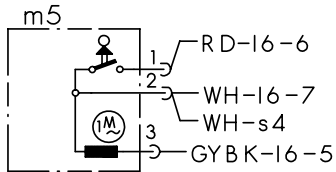

aktuator

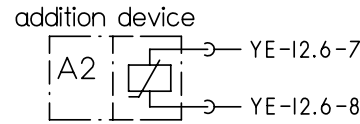

clutch

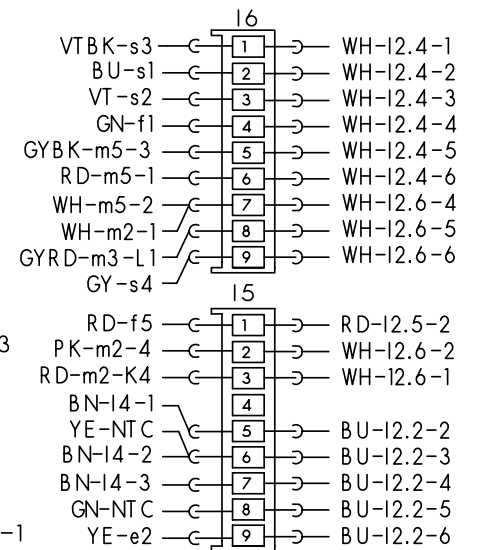

float switch

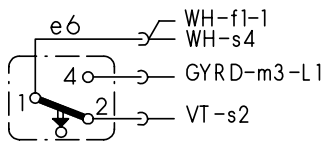

door switch

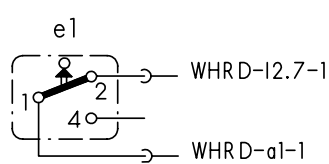

motor

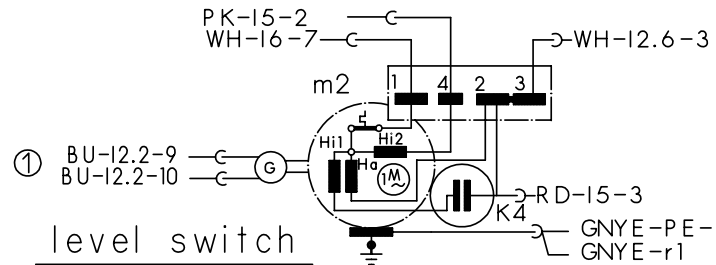

level switch

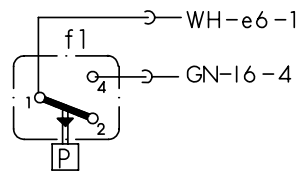

terminal ll with interference suppression

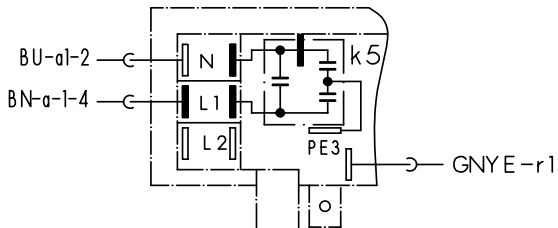

heating

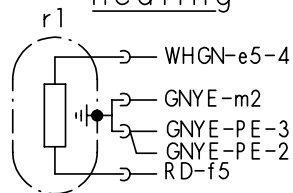

safety switch

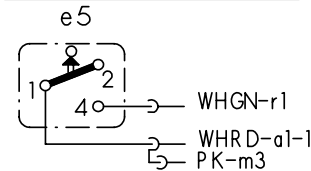

drain pump

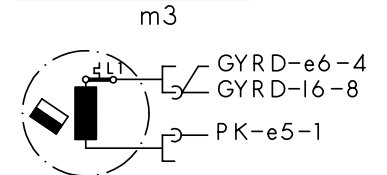

① exist according to equipment
 (..) previous color



Mat.Nr.: 9000002401	
Ausg.: 01.04	S0-60/0859

Modul K1 + K2

8:88

12.

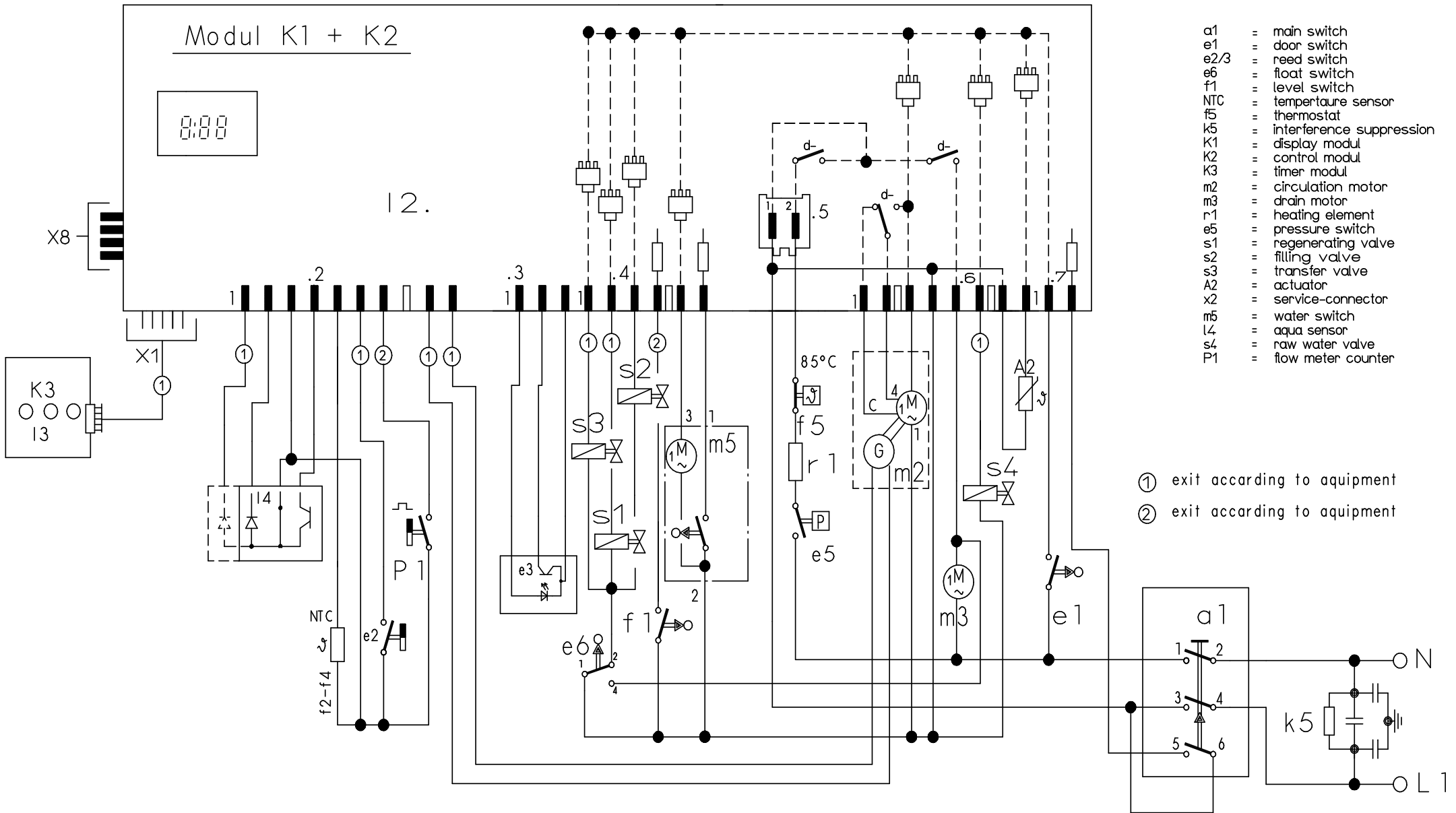

- a1 = main switch
- e1 = door switch
- e2/3 = reed switch
- e6 = float switch
- f1 = level switch
- NTC = temperature sensor
- f5 = thermostat
- k5 = interference suppression
- K1 = display modul
- K2 = control modul
- K3 = timer modul
- m2 = circulation motor
- m3 = drain motor
- r1 = heating element
- e5 = pressure switch
- s1 = regenerating valve
- s2 = filling valve
- s3 = transfer valve
- A2 = actuator
- x2 = service-connector
- m5 = water switch
- L4 = aqua sensor
- s4 = raw water valve
- P1 = flow meter counter

- ① exit according to aequipent
- ② exit according to aequipent

Mat. Nr. 5600049107	
Ausg.: 12.03	S0-60/0662



Customer service test programme

1. Selecting the model coding:

Switch off the appliance. When the door is closed, hold down two buttons and press main switch until the model coding is indicated on the display.

2. Select special programme:

When the two buttons are released, LED L5 lights up and LED L6 flashes. P0 is displayed. The required special programme can be selected by pressing the S5 button.

- **P0** = Read out fault memory
- **P1** = Customer service test programme
- **P2/P3** = In-plant test programmes
- **P4** = Model coding

Press S6 to acknowledge the selected programme.

3. Read out fault memory (P0)

The faults of the last 8 wash cycles can be scanned by pressing the S6 button. When the button is pressed, the wash cycle is displayed (00 – 07). When the button is released, the associated fault is displayed (see table). If several faults occur in a wash cycle, only the fault with the highest value is displayed. The customer service programme can be started by pressing the S5 button.

4. Customer service test programme (P1)

The customer service programme starts as soon as the programme P1 is acknowledged (with S6). While the customer service programme is running, each status change of the analogue signal inputs (e.g. limit switch for position of water points) is acknowledged by the electronics module with LEDs which flash briefly. The particular programme position is indicated via the display. The water points are active in the circulation positions.

Switch to the next programme position with the S5 button.

(Exception: Move to the next filling step by pressing filling switch F1 only).

A fault which has occurred is indicated immediately via the display (heating fault after 60 minutes). If several faults occur, only the fault with the highest value is displayed. Following each repair a customer service test programme must be run to detect any other faults.

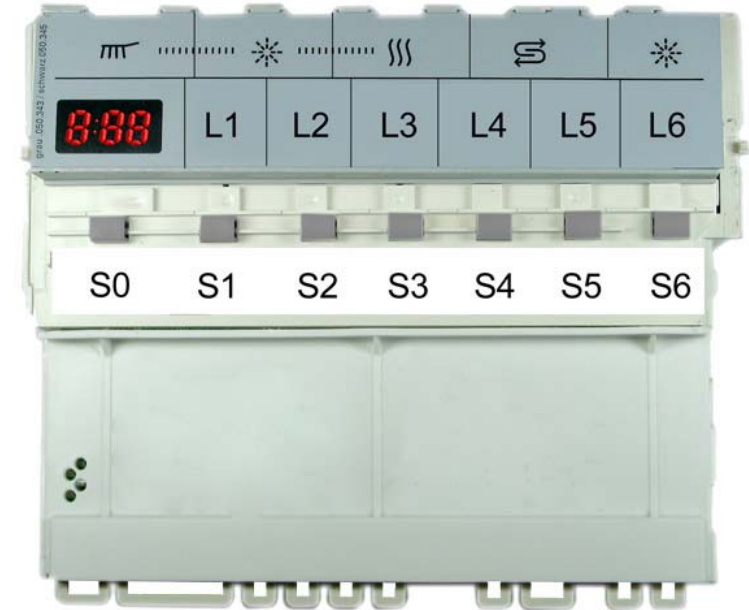

Document No. 56000000110104 ASP EN A	Rev. A	Sheet-No. 1 of 2
Material No. 5600 061 511	GV634 , L , WT	

Fault code:

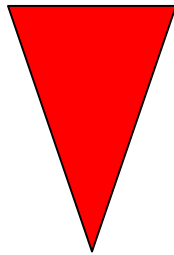
Fault code	Fault type	Value
E01	Heating fault	
E02	NTC fault	
E03	Filling fault	
E04	Water points cannot be positioned	
E05	Tachogenerator	
E06	Aqua sensor	
E07	---	

Sequence of the customer service test programme:

	Function	Temperature	Capacity	Time (s)	Sensor	Symbol
S:00	P			15		P = Pump
S:01	VF				F1	VF = Prefill
S:02	PA			5		F = Fill (level F1)
S:03	F + reversal relay/auxiliary winding (SICASYM)		3,9	X + 10		U = Circulate
S:04	U + H + ZR	max. 72°		120		H = Heat
S:05	U + H	60 °C				ZR = Dispense detergent
S:06	U + H + R	max. 72°		120		ZK = Dispense rinse aid
S:07	U + ZK			120		R = Regeneration valve
S:08	AS_KAL_IR					FWW = Fill soft water
S:09	WP			30		AS_KAL = Calibrate Aqua sensor
S:10	P			45		AWT = Heat exchanger outlet valve
S:11	FWW + AWT			60		WP = Alternating pump
S:12	SP			30		SP = Intermittent pump
S:13	P + AWT			30		PA = Pause
						X = Calculated refill time

Document No. 56000000110104 ASP EN A	Rev. A	Sheet-No. 2 of 2
Material No. 5600 061 511	GV634 , L , WT	