

Hauptschalter

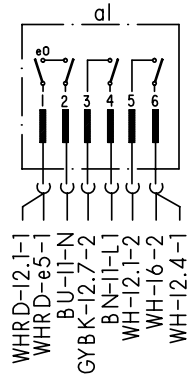

Zeitvorwahl, Bedien- u. Steuermodul

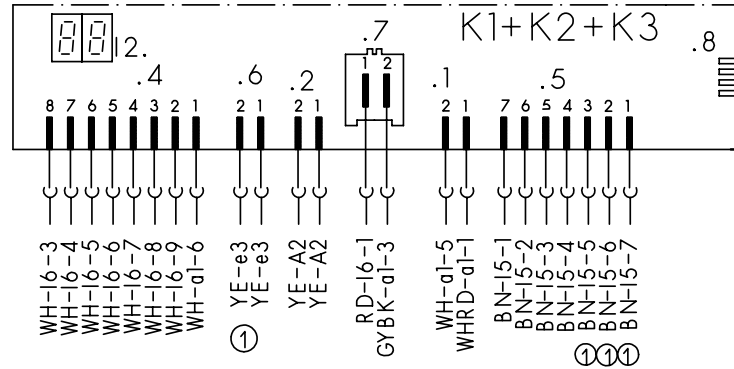

Reedschalter

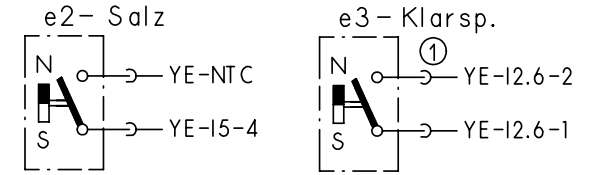

Schutzleiter

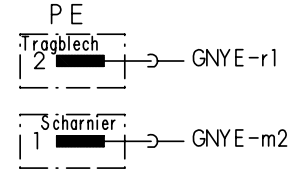

Aqua-Sensor

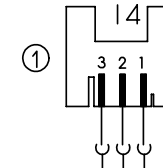

Kupplung

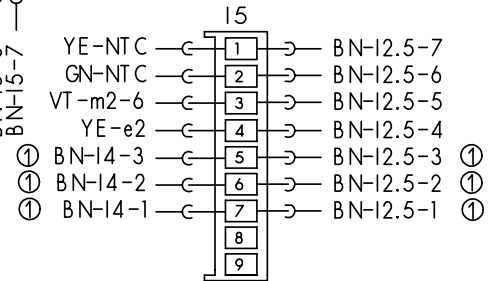

Wasserweiche

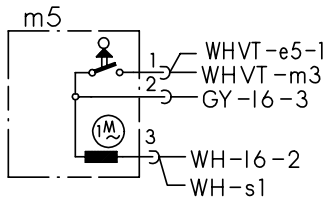

Niveaudruckdose

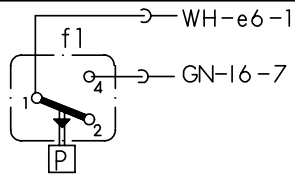

Temperaturregler + NTC

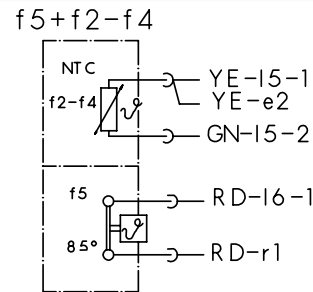

Aktuator

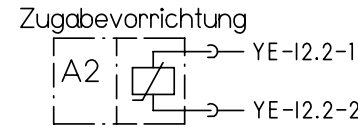

Schwimmersch.

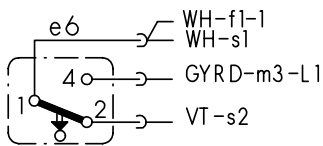

Magnetventile

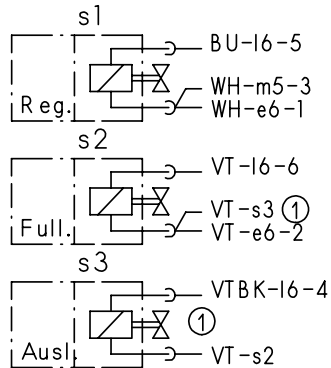

Sicherheitssch.

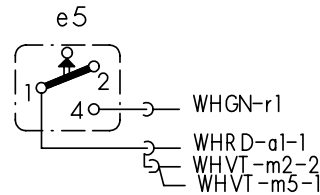

Motor

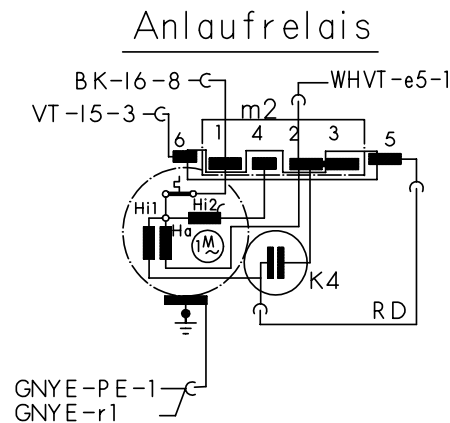

Klemme I1 mit Entstoerung

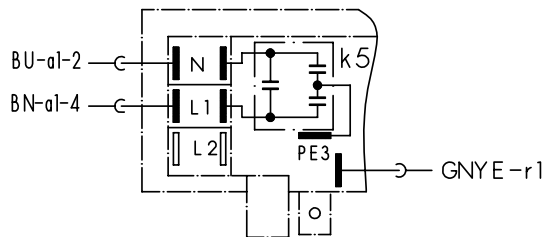

Heizung

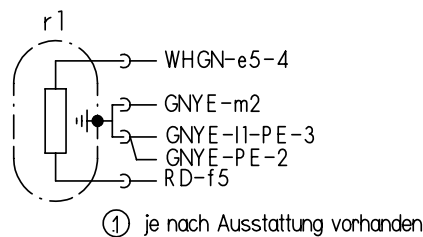

① je nach Ausstattung vorhanden

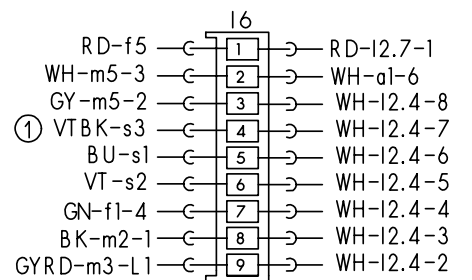

Laugenpumpe

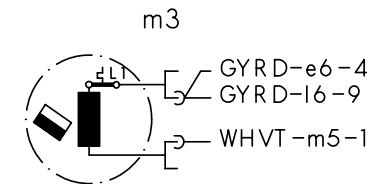

Mat.Nr.: 5600049105	
Ausg.: 04.02	SO-60/0665

