

display

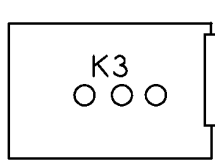

on-off and selector switch

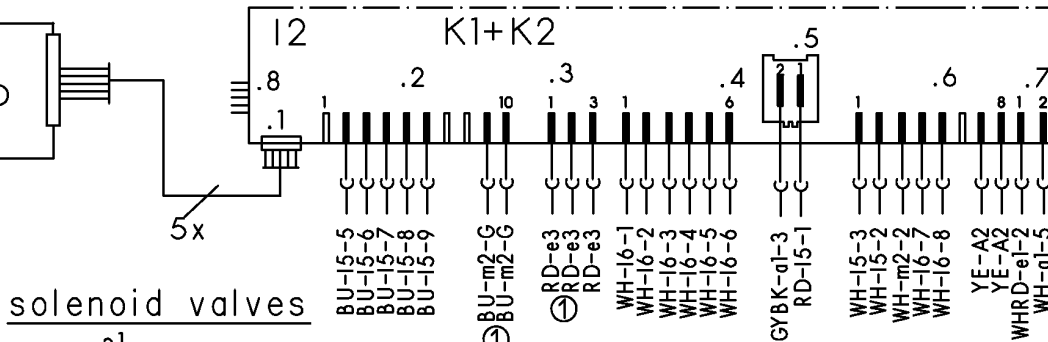

sensor

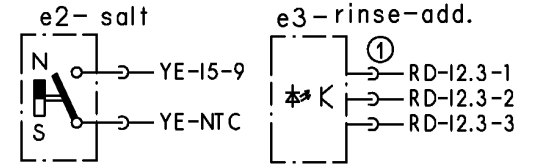

main switch

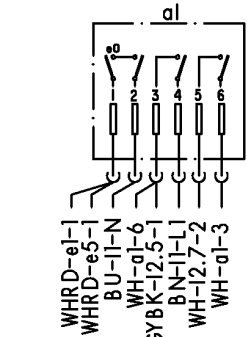

aqua-sensor

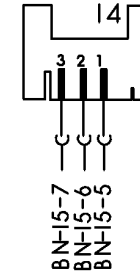

earth terminal

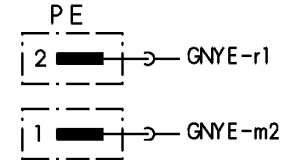

solenoid valves

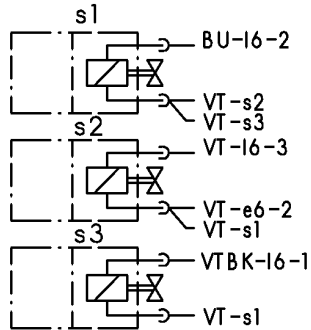

thermostat + NTC

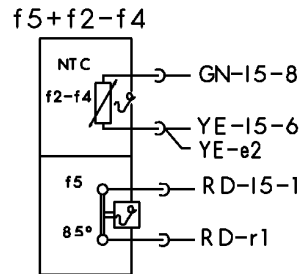

aktuator

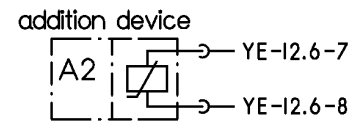

water points

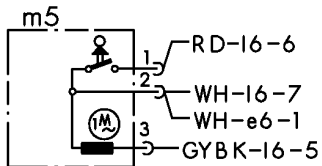

clutch

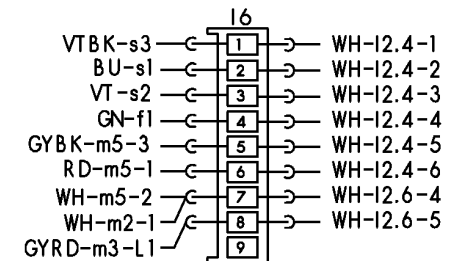

float switch

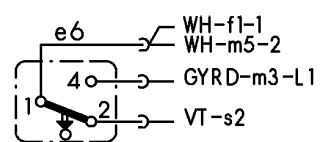

door switch

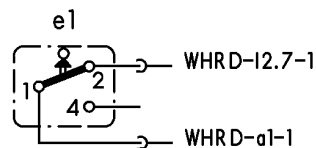

motor

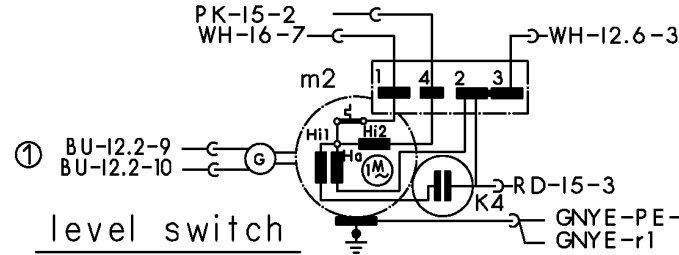

level switch

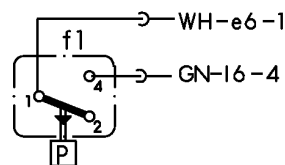

safety switch

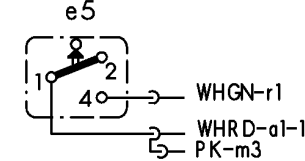

drain pump

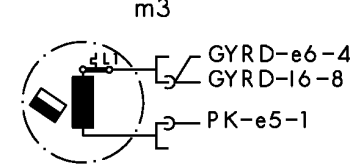

terminal ll with interference suppression

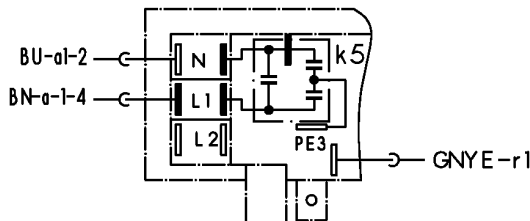

heating

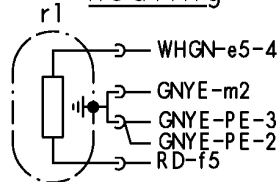

① exist according to equipment  
(.) previous color



Mat.Nr.: 5600049106	
Ausg.: 09.02	S0-60/0661

# 12. Modul K1 + K2

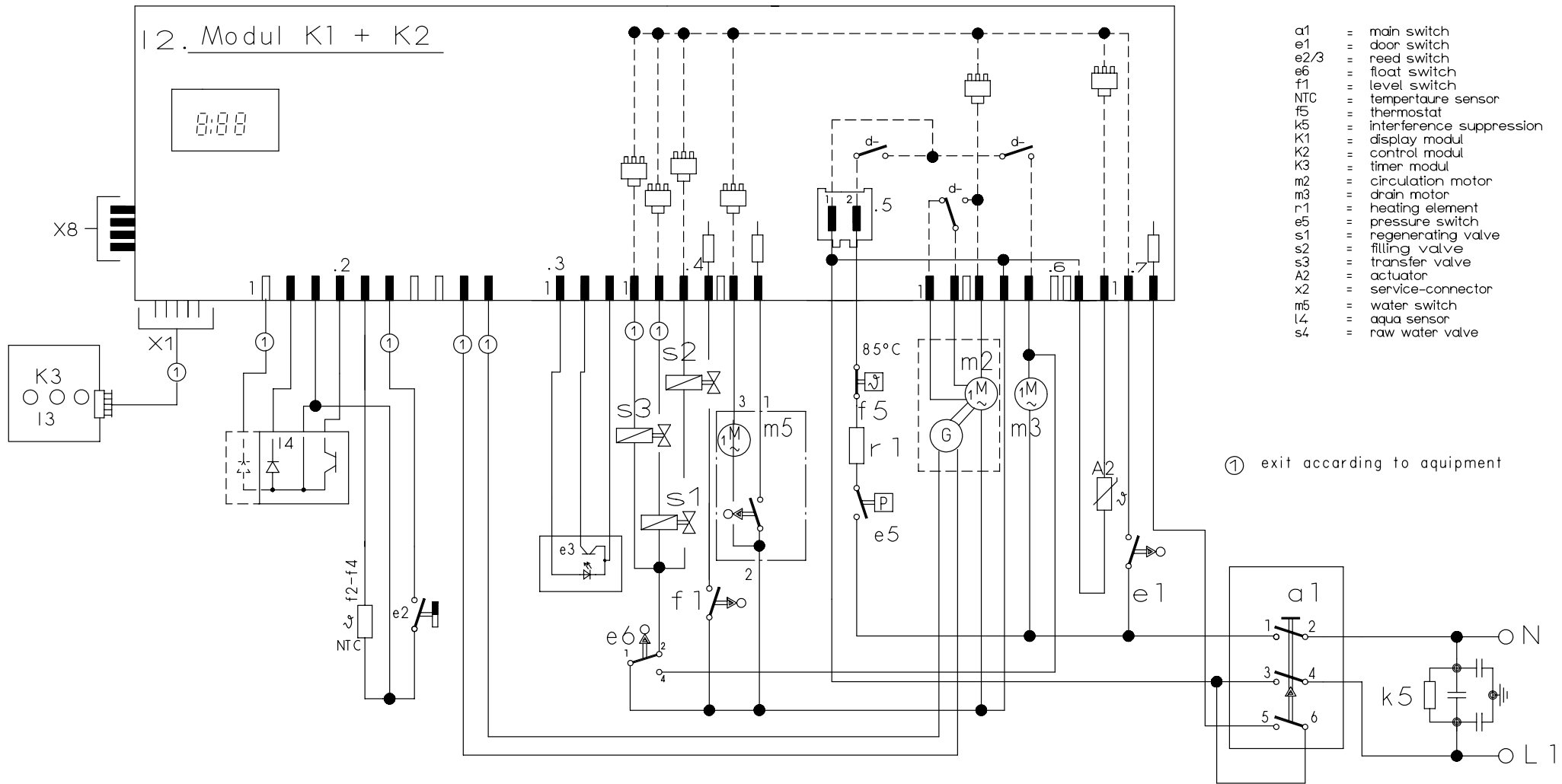

- a1 = main switch
- e1 = door switch
- e2/3 = reed switch
- e6 = float switch
- f1 = level switch
- NTC = temperature sensor
- f5 = thermostat
- k5 = interference suppression
- K1 = display modul
- K2 = control modul
- K3 = timer modul
- m2 = circulation motor
- m3 = drain motor
- r1 = heating element
- e5 = pressure switch
- s1 = regenerating valve
- s2 = filling valve
- s3 = transfer valve
- A2 = actuator
- x2 = service-connector
- m5 = water switch
- L4 = aqua sensor
- s4 = raw water valve

① exit according to aqipment

GB

Mat. Nr. 5600049107	
Ausg.: 06.02	S0-60/ 0662

# Customer service test programme

## 1 Selection:

Switch off the appliance. When the door is closed, hold down two buttons and press the main switch until the model code is displayed.

## 2 Select special programme:

When the two buttons are released, LED L5 illuminates and LED L6 flashes. P0 is displayed. Press button **S5** to select the required special programme.

- **P0** = Read out fault memory
- **P1** = Customer service test programme
- **P2/P3** = Factory test programmes
- **P4** = Model code

**Press S6 to acknowledge the selected programme.**

## Read out fault memory (P0)

Press button S6 to scan the faults of the last 8 rinse cycles. When the button is pressed, the rinse cycle is displayed (00 – 07). When the button is released, the associated fault (see table) is displayed. If several faults occur in one rinse cycle, only the fault with the highest value is displayed. Press button S5 to start the customer service programme.

## Customer service test programme (P1)

When programme P1 is acknowledged (with S6), the customer service programme starts immediately. The particular programme position is indicated on the display. The water points are active in the circulating positions.

Press button S5 to move to the next programme position.  
(Exception: Move to the next filling step by pressing filling switch F1 only)

A fault which has occurred is displayed immediately (heating fault after 60 minutes). If several faults occur, only the fault with the highest value is displayed. Following each repair, a customer service test programme must be run in order to detect any other faults.

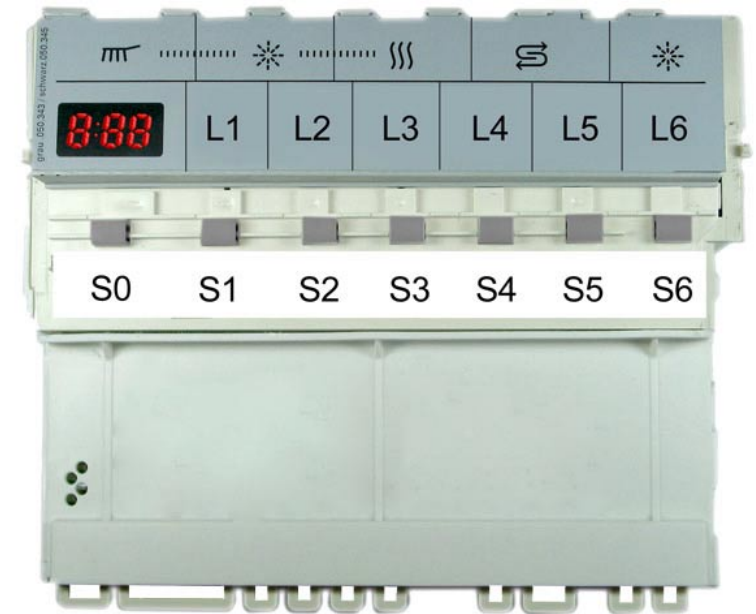

5600.049.712	Ausg.:10.02
L, WT, GV630	S0-60/0734 2/1

**Fault code:**

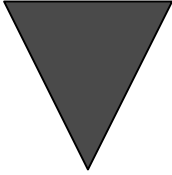
Fault code	Fault type	Value
E0	Not a fault	<div style="text-align: center;">                     High                        Low                 </div>
E1	Heating fault	
E2	NTC fault	
E3	Filling fault	
E4	Water points cannot be positioned	
E5	Tachogenerator	
E6	Aqua sensor	
E7	- - -	

**Sequence of the customer service test programme:**

	Function	Temperature	Capacity	Time (s)	Sensor	Symbol
S:00	P			15		P = Pump
S:01	VF				F1	VF = Prefill
S:02	F + AWT + U (circulation after 20s for 100s)		3.9 l			F = Fill (level F1)
S:03	U + H + ZR	max. 72°C		120		U = Circulate
S:04	U + H	60°C				H = Heat
S:05	U + H + R	max. 72°C		120		ZR = Dispense detergent
S:06	U + ZK			120		ZK = Dispense rinse aid
S:07	AS_KAL			max. 120		R = Regeneration valve
S:08	WP			30		FWW = Fill soft water
S:09	P			45		AWT = Heat exchanger outlet valve
S:10	FWW + AWT			60		AS_KAL= Calibrate Aqua sensor
S:11	SP			30		WP = Alternating pumping
S:12	P + AWT			30		SP = Intermittent pumping

5600.049.712	Ausg.:10.02
L, WT, GV630	S0-60/0734 2/2

# Model code

## 1. Selection:

When the door is closed, hold down two buttons and press the main switch until the model code is displayed.

## 2. Select special programme:

When the two buttons are released, **LED L5** illuminates and **LED L6** flashes.

**P0** is displayed. Press button **S5** to select the required special programme. Keep pressing **S5** until **P4** is displayed.

Press **S6** to acknowledge the selected programme.

## 3. Select model:

Press button **S5** to select the different codes according to the programme symbols (see table).

Switch off the appliance to save the new code.

### Code table:

S0	S1	S2	S3	S4	S5	S6	Display
							C1
Timer programming	Top basket	Intensive 70°	Auto 55°/65°	ECO 50°	Quick 35°	Prerinse	C2
Timer programming	Reduce time	Intensive 70°	Auto 55°/65°	ECO 50°	Gentle 40°	Quick 35°	C3
Timer programming	Reduce time	Intensive 70°	Auto 55°/65°	ECO 50°	Quick 35°	Prerinse	C4
Timer programming	Intensive 70°	Auto 55°/65°	ECO 50°	Gentle 40°	Quick 35°	Prerinse	C5
Timer programming	Reduce time	Soaking	Intensive 70°	Auto 55°/65°	ECO 50°	Gentle 40°	C6

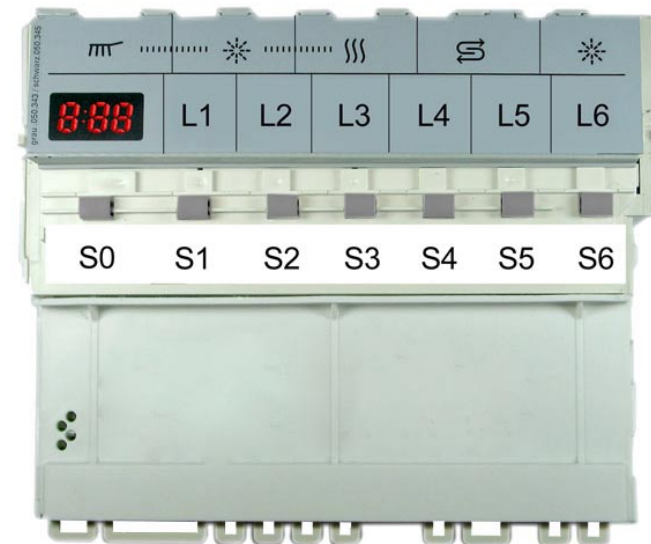

5600.054.372	Ausg.: 04.03
L, WT, GV630	S0-60/0736