

display

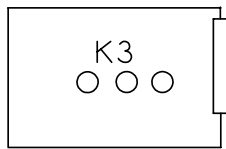

on-off and selector switch

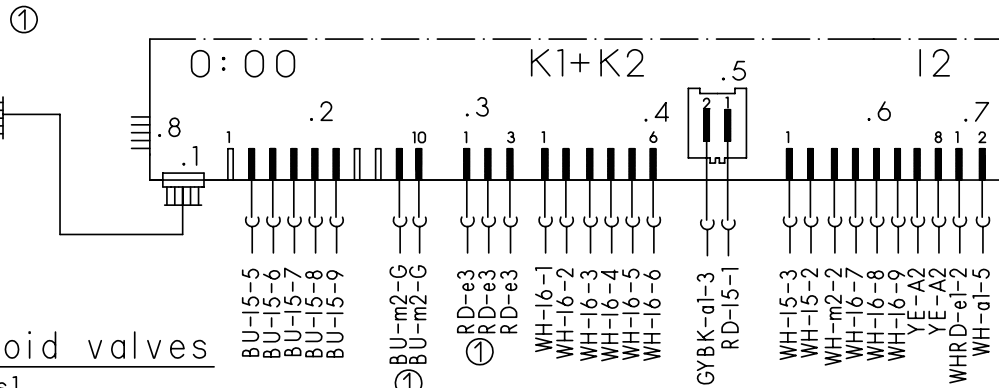

sensor

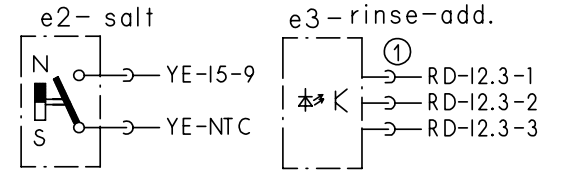

main switch

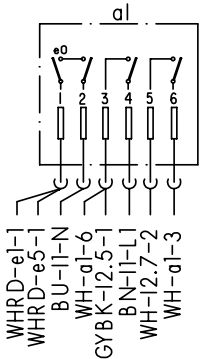

aqua-sensor

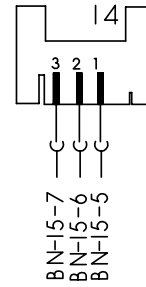

earth terminal

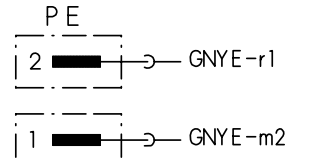

solenoid valves

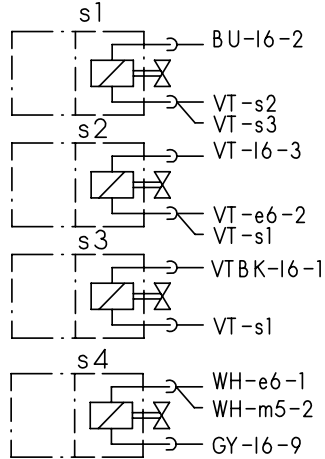

thermostat + NTC

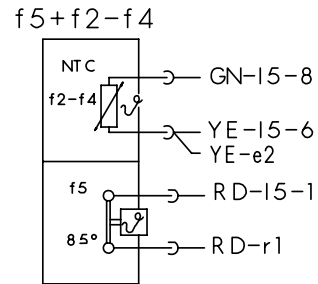

aktuator

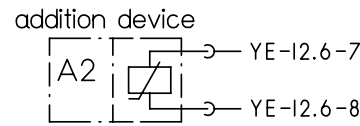

water points

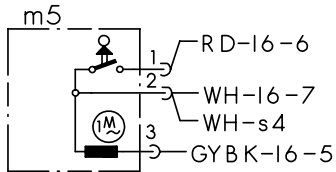

clutch

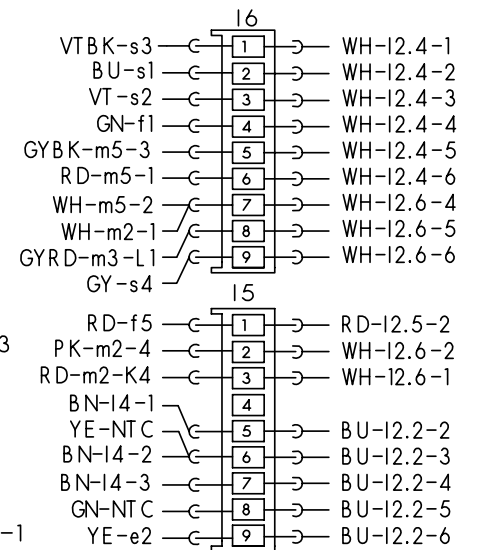

float switch

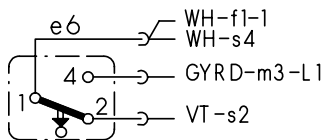

door switch

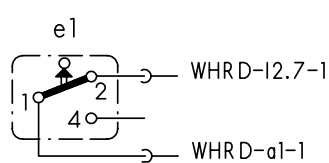

motor

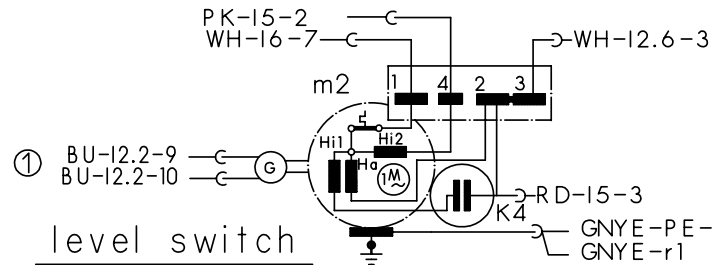

level switch

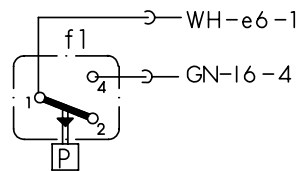

terminal l1 with interference suppression

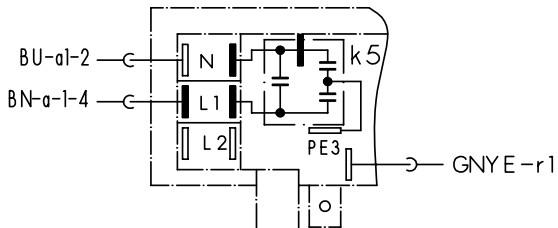

heating

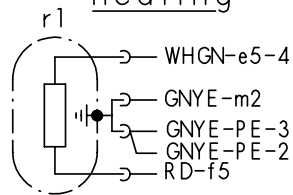

drain pump

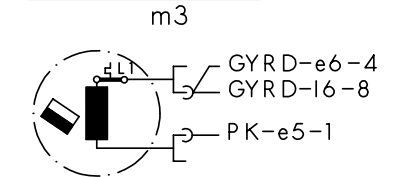

① exist according to equipment  
 (..) previous color



Mat.Nr.: 9000002401	
Ausg.: 01.04	S0-60/0859

Modul K1 + K2

8:88

12.

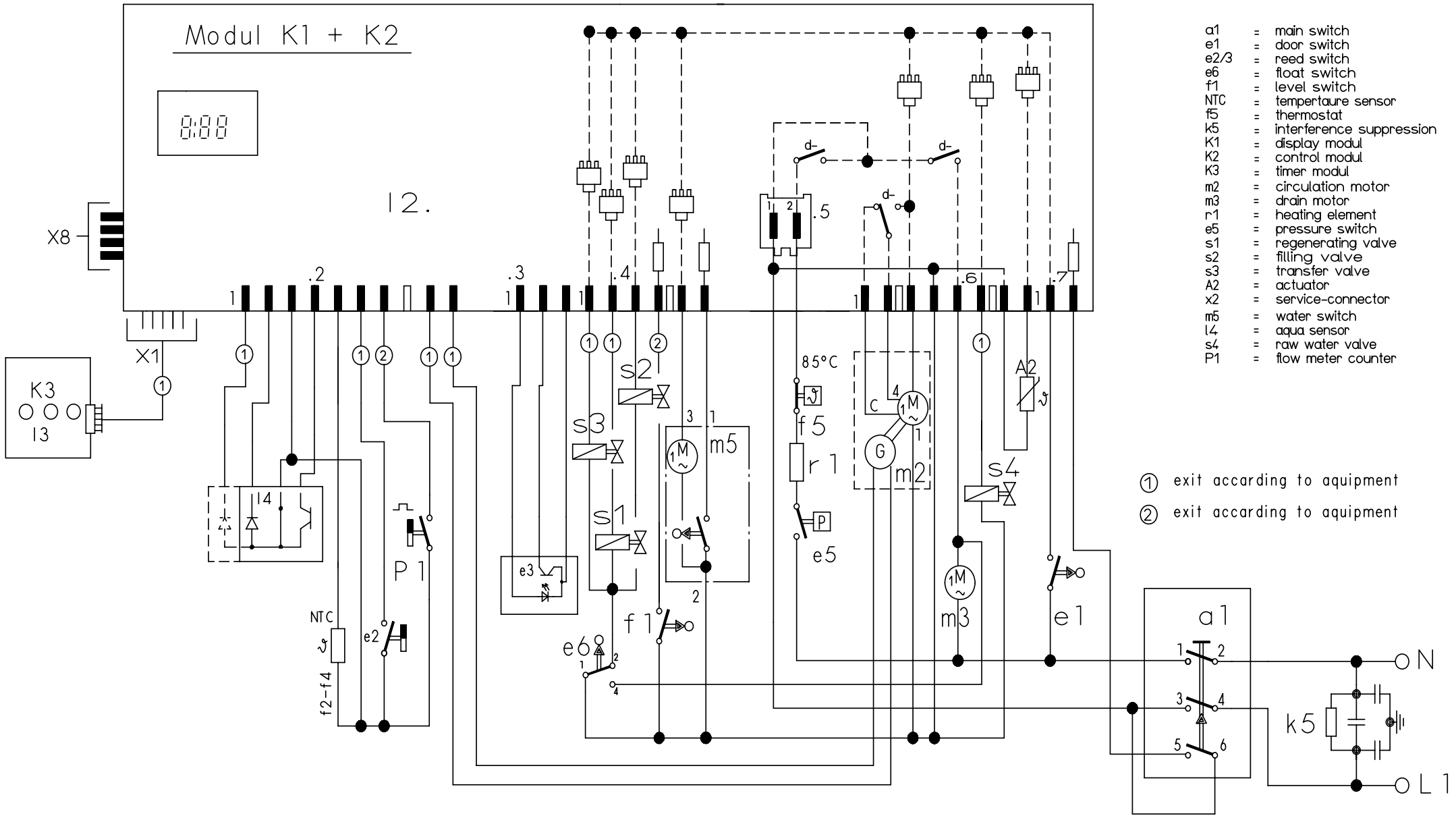

- a1 = main switch
- e1 = door switch
- e2/3 = reed switch
- e6 = float switch
- f1 = level switch
- NTC = temperature sensor
- f5 = thermostat
- k5 = interference suppression
- K1 = display modul
- K2 = control modul
- K3 = timer modul
- m2 = circulation motor
- m3 = drain motor
- r1 = heating element
- e5 = pressure switch
- s1 = regenerating valve
- s2 = filling valve
- s3 = transfer valve
- A2 = actuator
- x2 = service-connector
- m5 = water switch
- L4 = aqua sensor
- s4 = raw water valve
- P1 = flow meter counter

- ① exit according to equipment
- ② exit according to equipment

Mat. Nr. 5600049107	
Ausg.: 12.03	S0-60/0662

GB

# Customer service test programme

## 1 Selecting the model coding:

Switch off the appliance. When the door is closed, hold down two buttons and press main switch until the model coding is indicated on the display.

## 2 Select special programme:

When the two buttons are released, LED L5 lights up and LED L6 flashes. P0 is displayed. The required special programme can be selected by pressing the S5 button.

- **P0** = Read out fault memory
- **P1** = Customer service test programme
- **P2/P3** = In-plant test programmes
- **P4** = Model coding

**Press S6 to acknowledge the selected programme.**

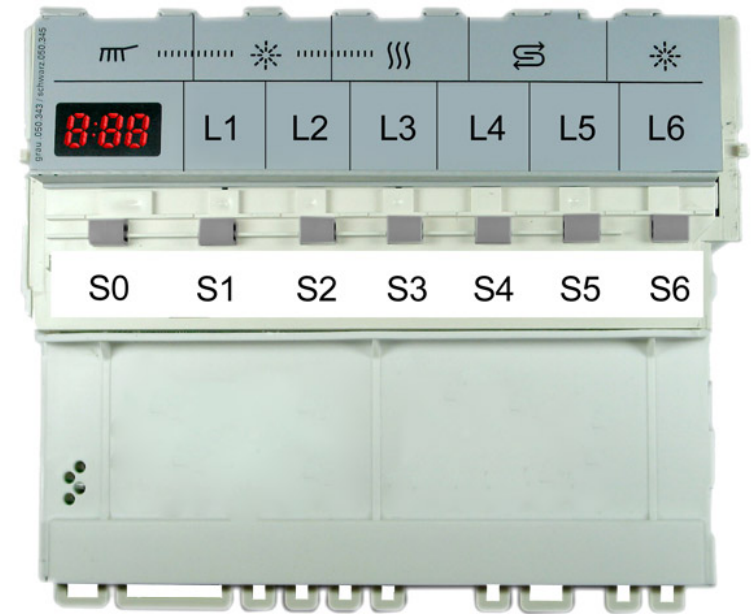

## Read out fault memory (P0)

The faults of the last 8 wash cycles can be scanned by pressing the S6 button. When the button is pressed, the wash cycle is displayed (00–07). When the button is released, the associated fault is displayed (see table). If several faults occur in a wash cycle, only the fault with the highest value is displayed. The customer service programme can be started by pressing the S5 button.

## Customer service test programme (P1)

The customer service programme starts as soon as the programme P1 is acknowledged (with S6). While the customer service programme is running, each status change of the analogue signal inputs (e.g. limit switch for position of water points) is acknowledged by the electronics module with LEDs which flash briefly. The particular programme position is indicated via the display. The water points are active in the circulation positions.

Switch to the next programme position with the S5 button.  
(Exception: Move to the next filling step by pressing filling switch F1 only).

A fault which has occurred is indicated immediately via the display (heating fault after 60 minutes). If several faults occur, only the fault with the highest value is displayed. Following each repair a customer service test programme must be run to detect any other faults.

5600.049.712	Ausg.:01.04
L, WT, GV630	S0-60/0734 2/1

**Fault code:**

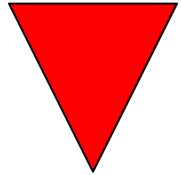
Fault code	Fault type	Value
E0	No fault	<div style="text-align: center;">  <p>High</p> <p>Low</p> </div>
E1	Heating fault	
E2	NTC fault	
E3	Filling fault	
E4	Water points cannot be positioned	
E5	Tachogenerator	
E6	Aqua sensor	
E7	- - -	

**Sequence of the customer service test programme:**

	Function	Temperature	Capacity	Time (s)	Sensor	Symbol
S:00	P			15		P = Pump
S:01	VF				F1	VF = Prefill
S:02	F + AWT + U (circulate after 20s for 100s)		3,9 L			F = Fill (level F1)
S:03	U + H + ZR	max. 72 °C		120		U = Circulate
S:04	U + H	60 °C				H = Heat
S:05	U + H + R	max. 72 °C		120		ZR = Dispense detergent
S:06	U + ZK			120		ZK = Dispense rinse aid
S:07	AS_KAL			max. 120		R = Regeneration valve
S:08	WP			30		FWW = Fill soft water
S:09	P			45		AWT = Heat exchanger outlet valve
S:10	FWW + AWT			60		AS_KAL= Calibrate Aqua sensor
S:11	SP			30		WP = Alternating pump
S:12	P + AWT			30		SP = Intermittent pump