

on-off and selector switch

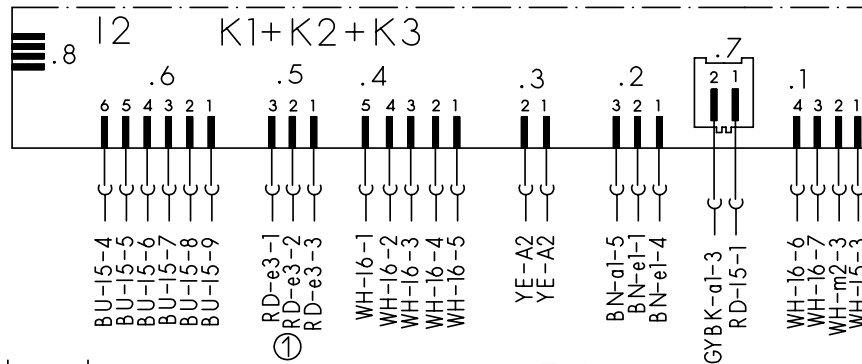

sensor

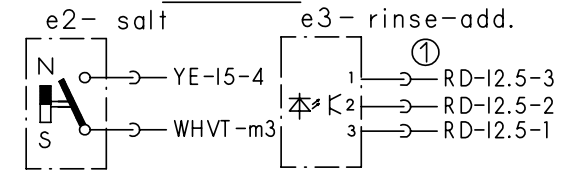

main switch

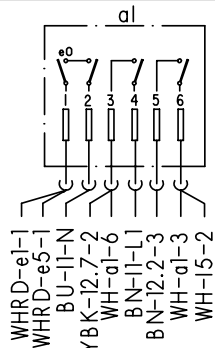

aqua-sensor

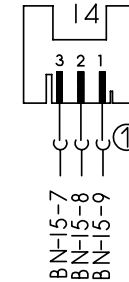

earth terminal

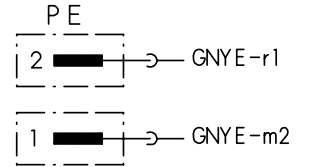

solenoid valves thermostat + NTC

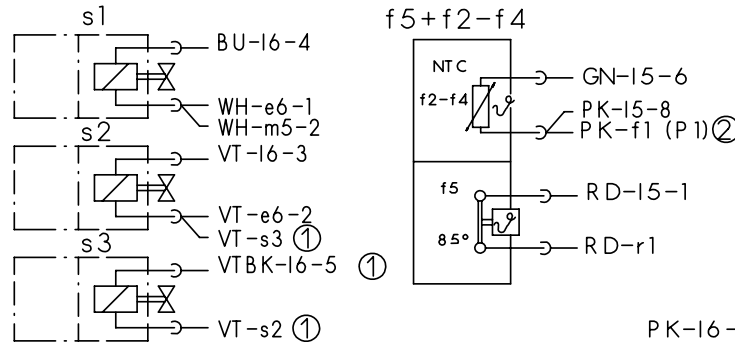

aktuator

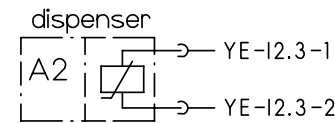

water points

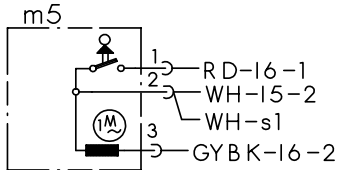

float switch

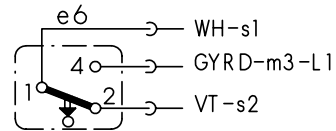

level switch

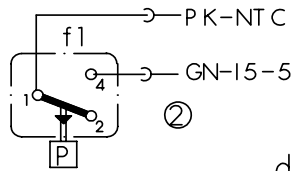

heating

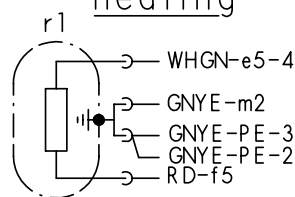

motor

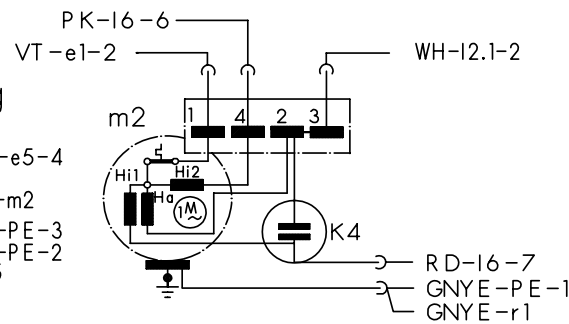

clutch

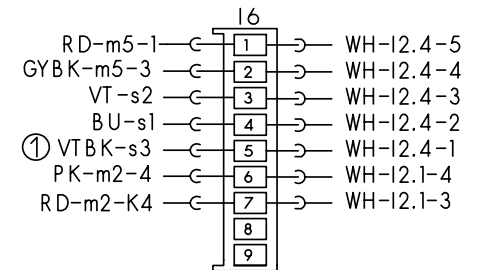

terminal I1 with interference suppression

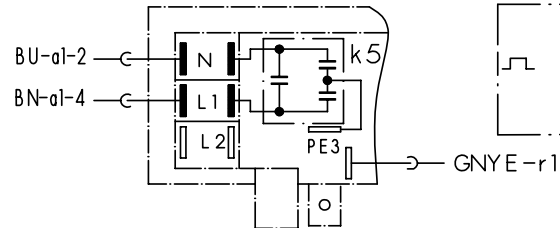

flowmeter

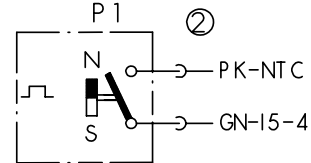

door switch

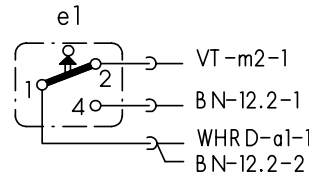

safety switch

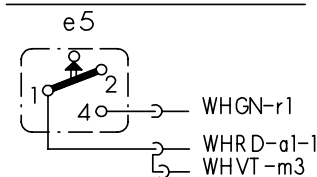

drain pump

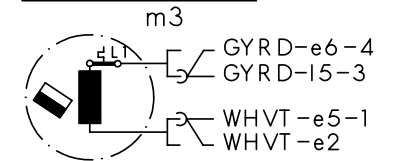

- ① exist according to equipment
- (.) previous color
- ② exist according to version



Mat.Nr.: 9000017140	
Ausg.: 04.04	S0-60/0894

The reproduction, transmission or use of this document or its contents is not permitted without express written authority. Offenders will be liable for damages. All rights including rights created by patent, grant or registration of a utility model or design are reserved. Copyright reserved.

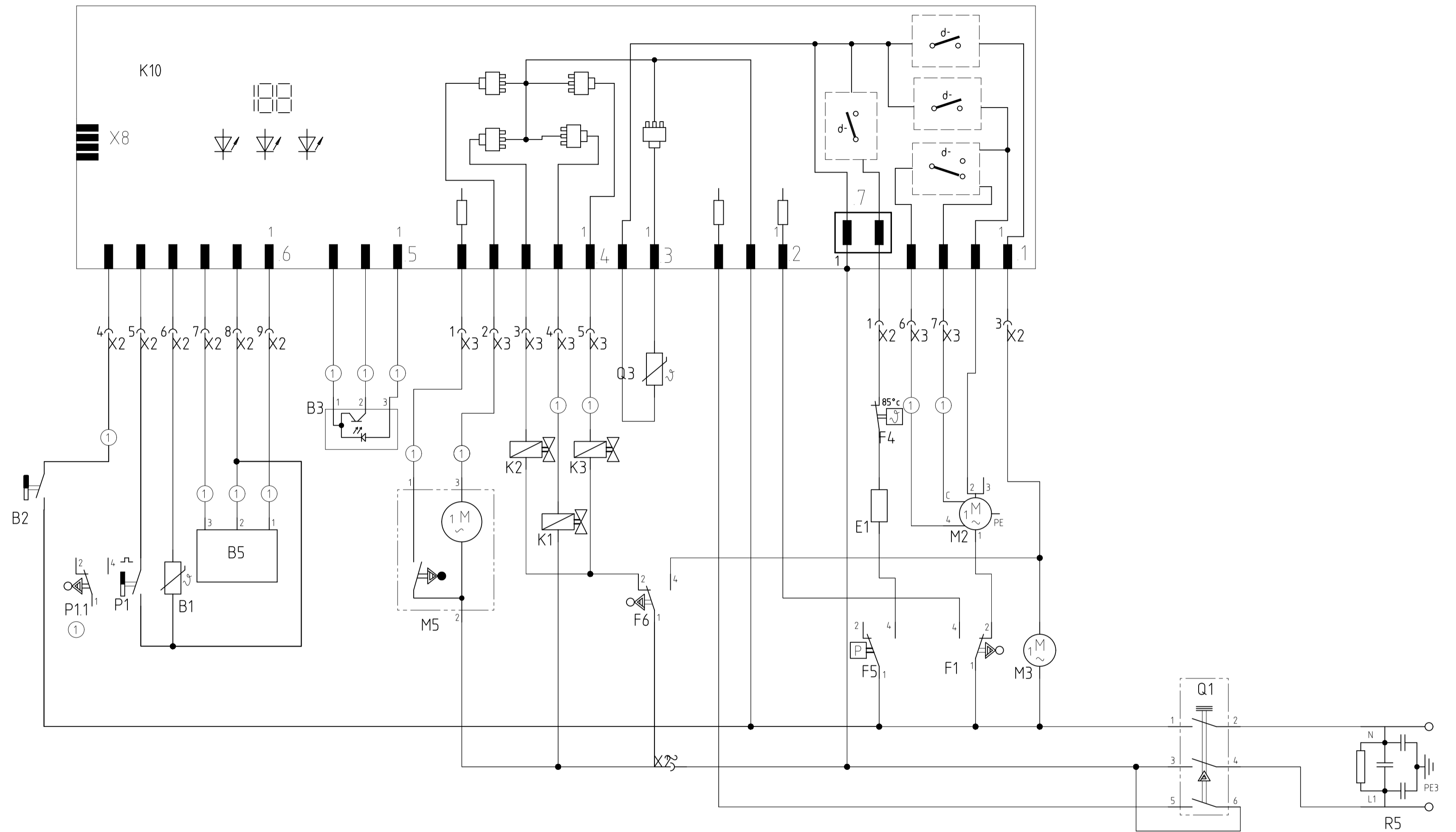

1 2 3 4 5 6 7 8 9 10 11 12 13 14 15 16 17 18 19 20 21 22 23 24 25 26 27 28 29 30 31 32 33 34 35 36 37 38 39 40 41 42 43 44 45 46 47 48 49 50 51 52 53 54 55

REF	Components	Path	REF	Components	Path	REF	Components	Path
B1	Temperature sensor ntc	15	F6	safety pressure switch	29-31	P11	Level switch	12,13
B2	Low salt sensor	11	K1	Regeneration valve	27	Q1	Main switch	46,48
B3	Low rinse aid sensor optical	20-22	K2	Filler valve	26	Q3	Dispenser actuator	30
B5	Aqua sensor 1	16-18	K3	Drainage valve	28	R5	Mains connection with interference suppressor	52,54
E1	Heater	37	K10	Control unit	13-18,20-22,24-30,32-34,36-41			
E1	Heater		M2	Circulation pump sicasym	39-41			
F1	Door switch	39,40	M3	Detergent solution pump	42			
F4	Safety thermostat	37	M5	Water switch	22,24			
F5	Safety pressure switch	36,37	P1	Impeller meter	14			

① Fitted depending on features

# Customer service test program

## 1. Selection:

- Switch off the appliance and close the door.
- With the door closed, keep two buttons pressed and press the main switch until the LEDs L2 – L4 indicate the modification coding.

## 2. Selecting a special program:

- After both of the buttons have been released LED 3 will light up and LED 4 will blink.

## 3. . Read out fault memory

- Press button S4 to scan the faults of the last rinse cycle.
- By means of LED L2 – L4 an error which has occurred will be shown as an encoded error (see error code chart). If no error has occurred in the last rinsing cycle, LED L3 will continue to light up and LED L4 will still blink.

## 4. Customer service test program

- Acknowledge with button S3 after the error storage has been read out. The customer service program will start up.
- LED L4 will blink while the program is in operation.
- Any error which may occur will immediately be shown as an encoded error by the L2 – L4 LEDs (heating error after 60 minutes).
- If several errors occur only the most significant error will be shown.
- While the customer service program is in operation any change of state of the analogous signal entries (e.g. filling switch F1) will be acknowledged by the electronic system with a brief blink of the LEDs. (LED function test).
- The water diverter will be activated during the entire program.
- A customer service test program is to be run after every repair in order to determine any other possible errors.
- The S3 button can be used to progress to the next program position (exception: in the case of the filling step it is only possible to move on by means of the filling switch F1).

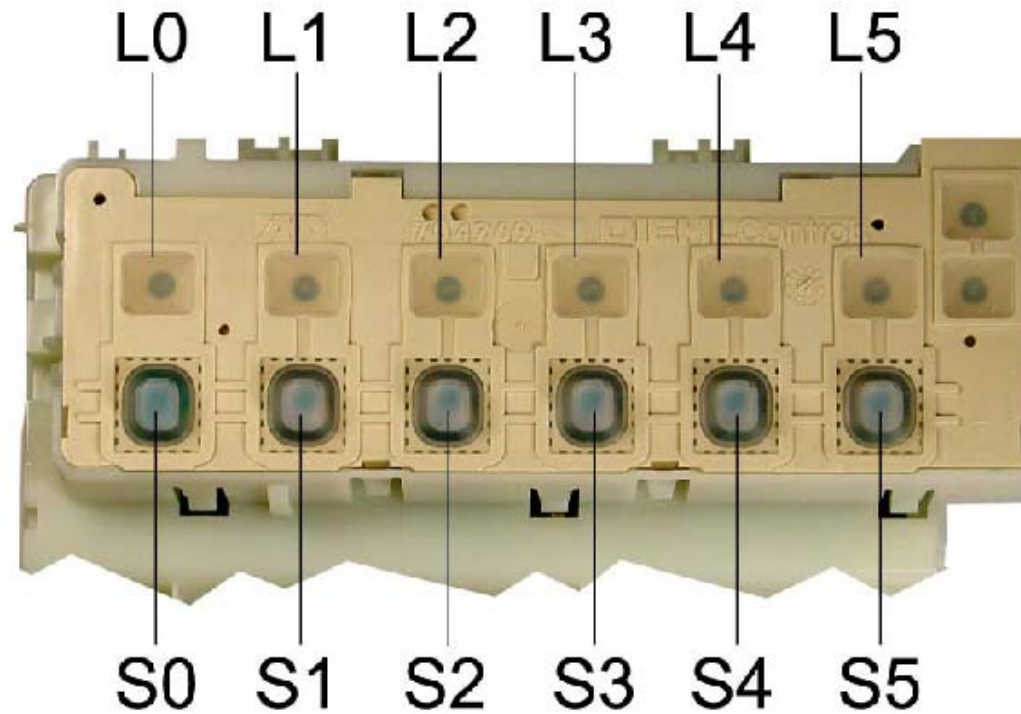

Document No. 58300000108139 ASP DE A	Rev. A	Sheet-No. 1 of 2
Material No. 9000 032 729	GV630 , H rati , WE, DS	

## Error code chart:

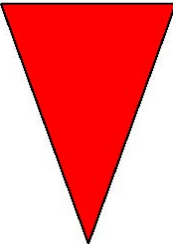
Error code no display			Type of error	Significance
L1	L2	L3		
○	○	✱	Heating error	
○	✱	○	NTC error	
○	✱	✱	Filling error	
✱	○	○	Water diverter cannot be positioned	
✱	○	✱	- - -	
✱	✱	○	Aqua sensor	
✱	✱	✱	- - -	

○ = LED off      ✱ = LED blinks rapidly (2Hz)

## Customer service test program sequence

	Function	Temperature	Capacity	Time (s)	Sensor	Abbreviation
1	P			15		P = Pump
2	VF		1.5 l			VF = Pre-fill
3	PA			5		F = Fill (level F1)
4	F + change-over relay/starting winding (SICASYM) U		2.4 l	X + 10		U = Circulate
5	U + H + ZR	max. 72°		120		H = Heat
6	U + H	60°C				ZR = Dispense detergent
7	U + H + R	max. 72°		120		ZK = Dispense clear rinse agent
8	U + H + ZK	max. 72°		120		R = Regeneration valve
9	WP			30		FWW = Fill up soft water
10	P			45		WP = Alternating pumping
11	FWW			60		SP = Sputter pumping
12	SP			30		PA = Pause
13	P			30		X = Refill time calculated

Document No. 58300000108139 ASP DE A	Rev. A	Sheet-No.
		2 of 2
Material No. 9000 032 729	GV630 , H rati , WE, DS	