

on-off and selector switch

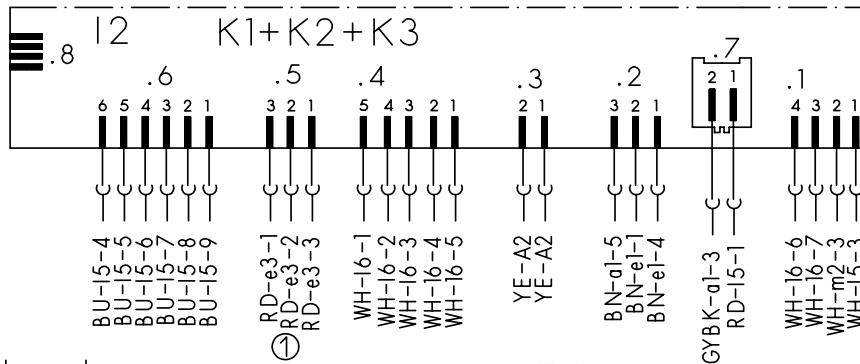

sensor

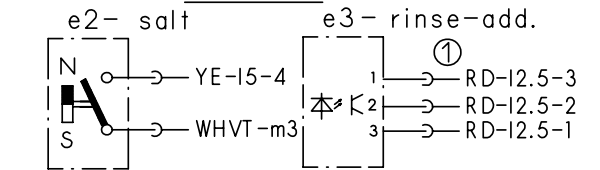

main switch

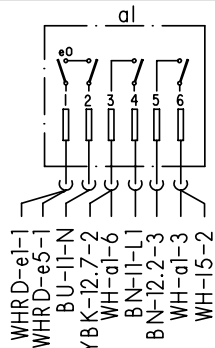

aqua-sensor

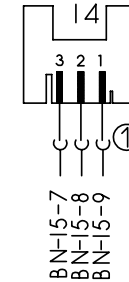

earth terminal

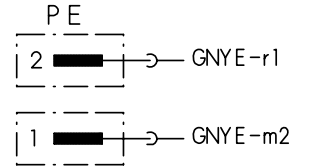

solenoid valves thermostat + NTC

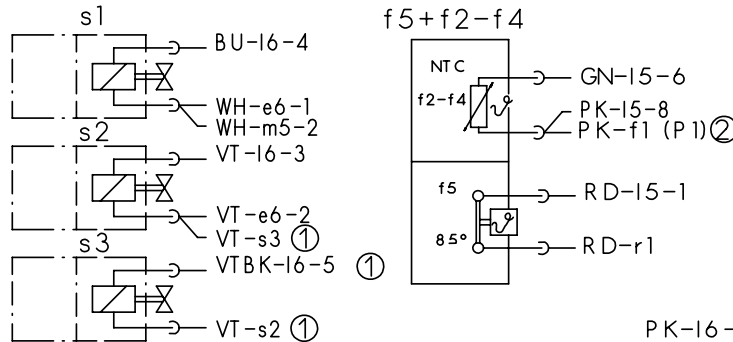

aktuator

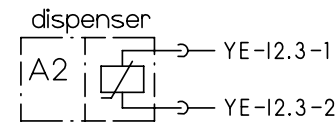

clutch

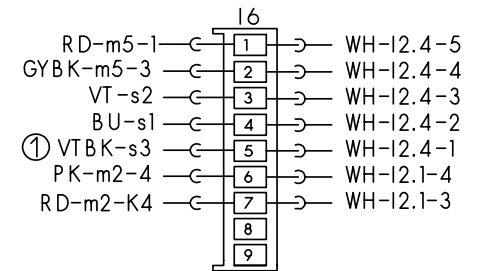

water points

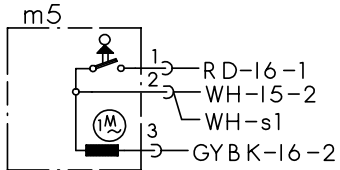

motor

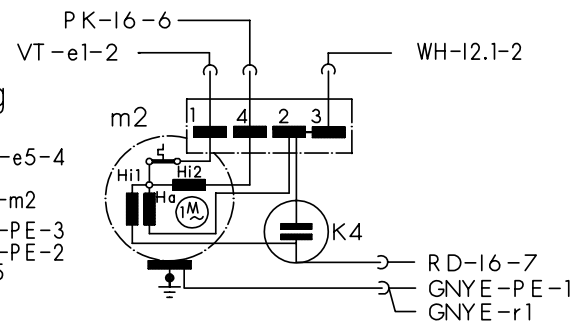

float switch

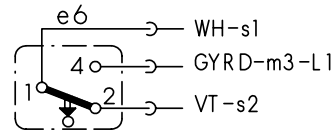

level switch

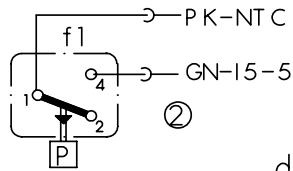

heating

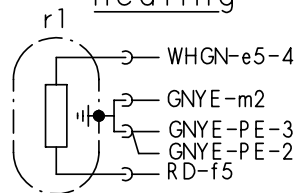

terminal I1 with interference suppression

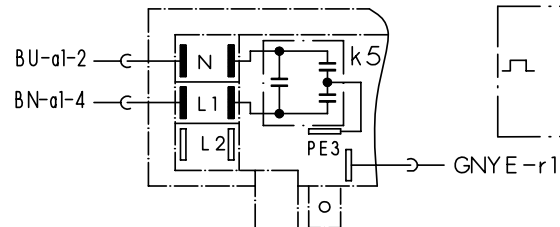

door switch

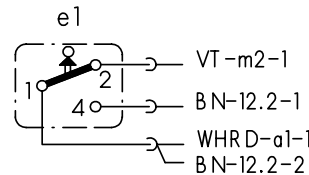

safety switch

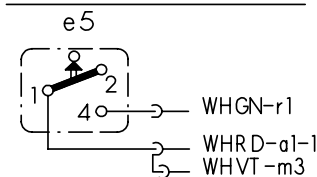

drain pump

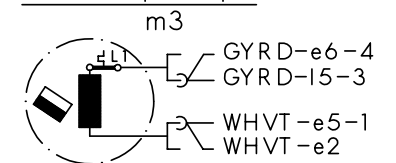

flowmeter

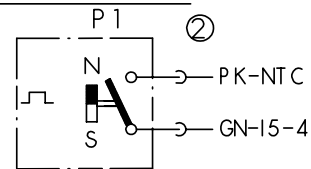

Mat.Nr.: 9000017140	
Ausg.: 04.04	S0-60/ 0894

- ① exist according to equipment
- (.) previous color
- ② exist according to version



The reproduction, transmission or use of this document or its contents is not permitted without express written authority. Offenders will be liable for damages. All rights including rights created by patent, grant or registration of a utility model or design are reserved. Copyright reserved.

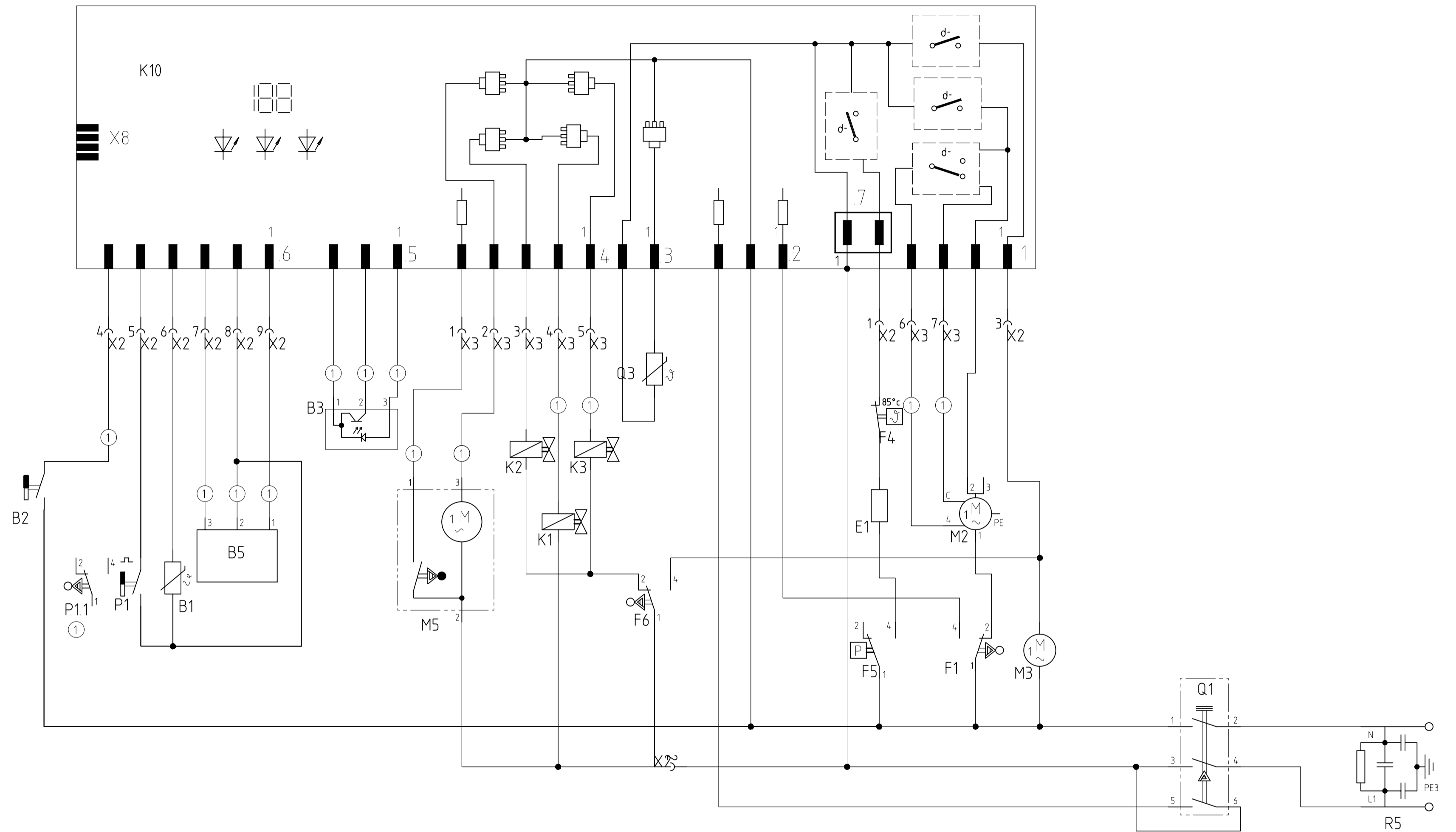

1 2 3 4 5 6 7 8 9 10 11 12 13 14 15 16 17 18 19 20 21 22 23 24 25 26 27 28 29 30 31 32 33 34 35 36 37 38 39 40 41 42 43 44 45 46 47 48 49 50 51 52 53 54 55

REF	Components	Path	REF	Components	Path	REF	Components	Path
B1	Temperature sensor ntc	15	F6	safety pressure switch	29-31	P11	Level switch	12,13
B2	Low salt sensor	11	K1	Regeneration valve	27	Q1	Main switch	46,48
B3	Low rinse aid sensor optical	20-22	K2	Filler valve	26	Q3	Dispenser actuator	30
B5	Aqua sensor 1	16-18	K3	Drainage valve	28	R5	Mains connection with interference suppressor	52,54
E1	Heater	37	K10	Control unit	13-18,20-22,24-30,32-34,36-41			
E1	Heater		M2	Circulation pump sicasym	39-41			
F1	Door switch	39,40	M3	Detergent solution pump	42			
F4	Safety thermostat	37	M5	Water switch	22,24			
F5	Safety pressure switch	36,37	P1	Impeller meter	14			

① Fitted depending on features

# Customer service test programme

## 1. Selecting the model coding:

Switch off the appliance. When the door is closed, hold down two buttons and press main switch until the model coding is indicated on the display.

## 2. Selecting the special programme:

When the two buttons are released, LED L3 lights up and LED L4 flashes. P0 is displayed. The required special programme can be selected by pressing the S3 button.

- **P0** = Read out fault memory
- **P1** = Customer service test programme
- **P2/P3** = In-plant test programmes
- **P4** = Model coding

Press **S6** to acknowledge the selected programme.

## 3. Read out fault memory (P0)

The faults of the last 8 wash cycles can be scanned by pressing the S4 button. When the button is pressed, the wash cycle is displayed (00 – 07). When the button is released, the associated fault is displayed (see table). If several faults occur in a wash cycle, only the fault with the highest value is displayed. The customer service programme can be started by pressing the S3 button.

## 4. Customer service test programme (P1)

The customer service programme starts as soon as the programme P1 is acknowledged (with S4). While the customer service programme is running, each status change of the analogue signal inputs (e.g. filling switch F1) is acknowledged by the electronics module with LEDs which flash briefly. The particular programme position is indicated via the display. The water points are actuated for as long as the programme is running. The LED L4 flashes for as long as the customer service programme is running.

Switch to the next programme position with the S3 button.

(Exception: Move to the next filling step by pressing filling switch F1 only)

A fault which has occurred is indicated immediately via the display (heating fault after 60 minutes). If several faults occur, only the fault with the highest value is displayed. Following each repair a customer service test programme must be run to detect any other faults.

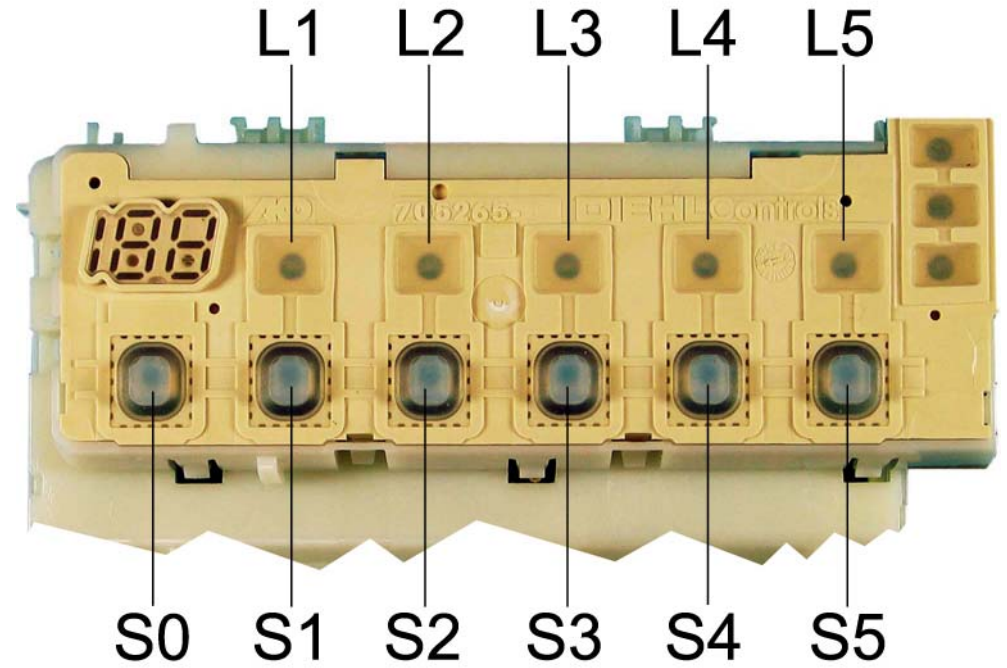

Document No. 58300000108135 ASP EN A	Rev. A	Sheet-No. 1 of 2
Material No. 9000 030 889	GV630 , G rati , WE, DS	

**Fault code:**

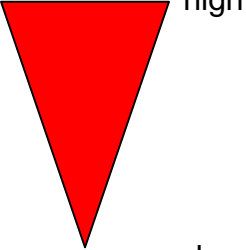
Fault code	Fault type	Value
E1	Heating fault	
E2	NTC fault	
E3	Filling fault	
E4	Water points cannot be positioned	
E5	- - -	
E6	Aqua sensor	
E7	- - -	

**Sequence of the customer service test programme:**

	Function	Temperature	Capacity	Time (s)	Sensor	Symbol
1	P			15		P = Pump
2	VF		1.5 l			VF = Prefill
3	PA			5		F = Fill (level F1)
4	F + reversal relay/auxiliary winding (SICASYM)		2.4	X + 10		U = Circulate
5	U + H + ZR	max. 72 °		120		H = Heating
6	U + H	60 °C				ZR = Dispense detergent
7	U + H + R	max. 72 °		120		ZK = Dispense rinse aid
8	U + H + ZK	max. 72 °		120		R = Regeneration valve
9	AS_KAL_IR					FWW = Fill soft water
10	WP			30		AS_KAL = Calibrate Aqua sensor
11	P			45		AWT = Heat exchanger outlet valve
12	FWW			60		WP = Alternating pump
13	SP			30		SP = Intermittent pump
14	P			30		PA = Pause
0	End					X = Calculated refill time

Document No. 58300000108135 ASP EN A	Rev. A	Sheet-No. 2 of 2
Material No. 9000 030 889	GV630 , G rati , WE, DS	