

Zeitvorwahl

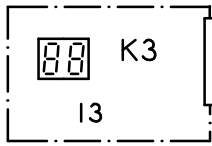

Anzeige - Bedienung + Steuermodul

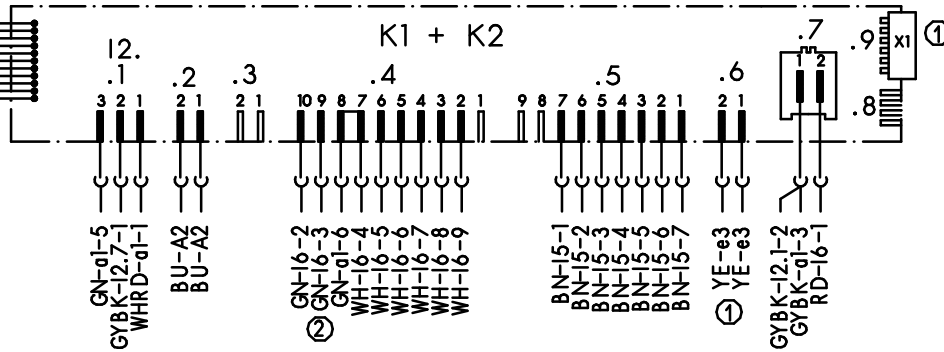

Reedschalter

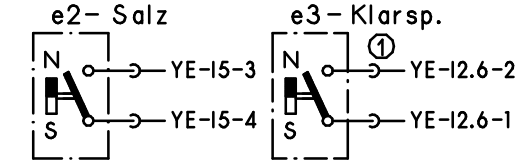

Hauptschalter

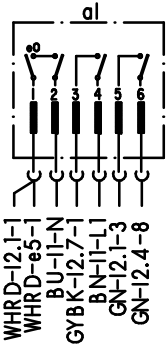

Aqua-Sensor

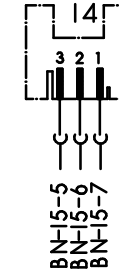

Schutzleiter

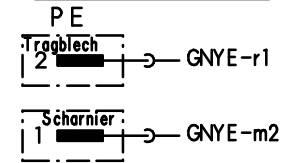

Schwimmersch.

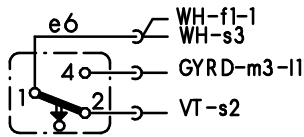

Niveaudruckdose

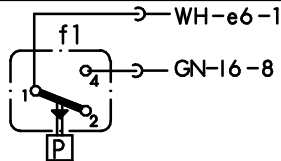

Temperaturregler + NTC

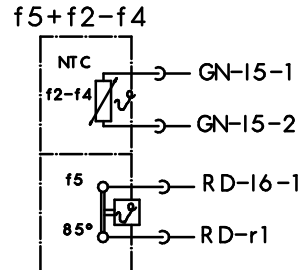

Magnetventile

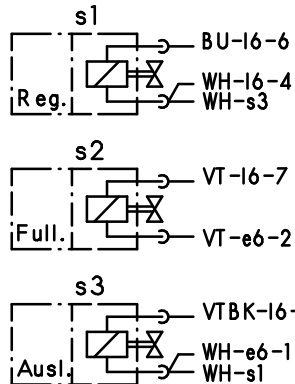

Aktuator



Kupplung

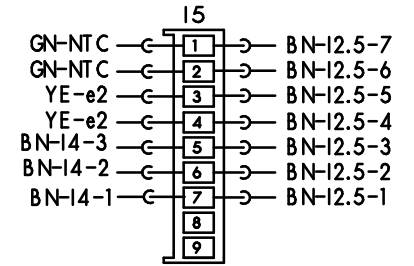

PTC-Motor ③

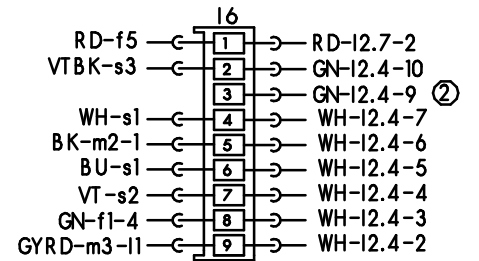
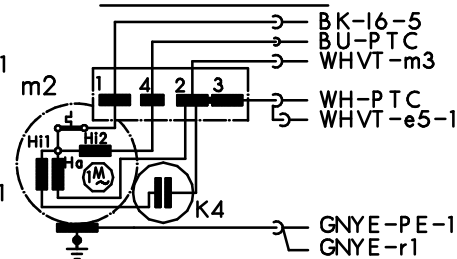

Klemme II mit Entstoerung

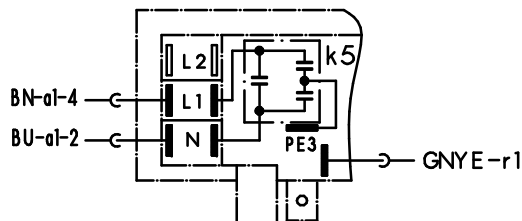

Heizung Sicherheitssch.

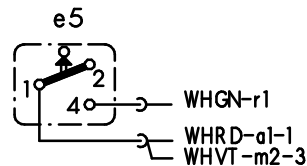
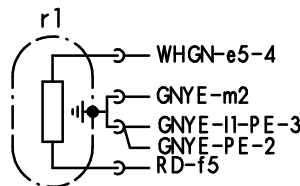

Laugenpumpe

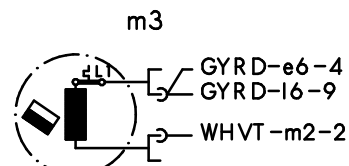

Anlaß-PTC ③

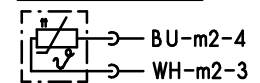

① je nach Ausstattung vorhanden
② wenn vorhanden ohne Funktion

③ je nach Motortyp



1 739 911 211	
Ausg.: 03.97	S0-60/0387

Materialnumber
 old 1739911174
 new 5600002023

Modul K3

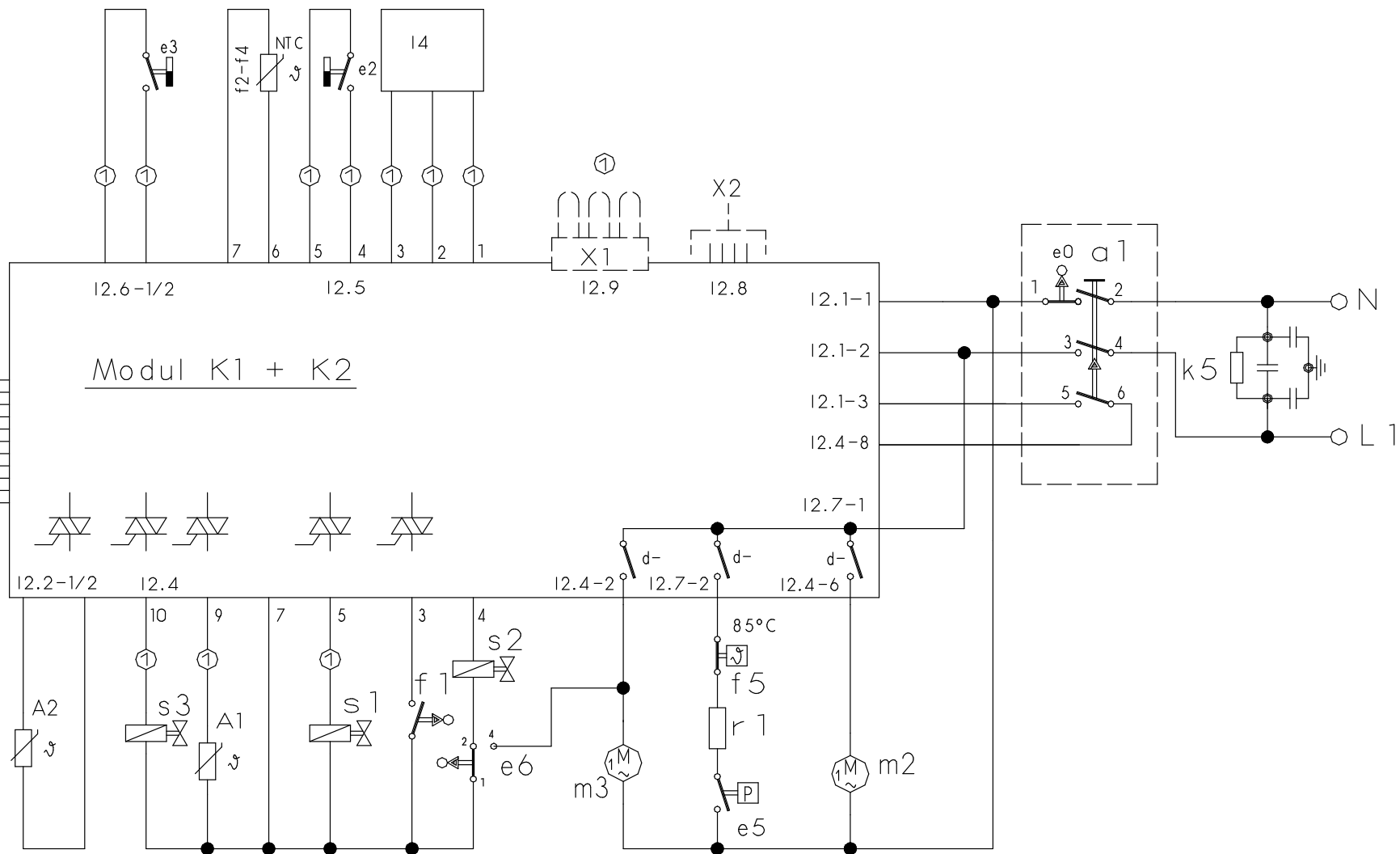
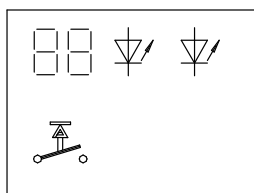

- | | |
|-------------------------------|---------------------------|
| a1 = main switch | m2 = circulation motor |
| e0 = door switch | m3 = drain motor |
| e2/3 = reed switch | r1 = heating element |
| e6 = float switch | e5 = pressure switch |
| f1 = level switch | s1 = regenerating valve |
| NTC = temperature sensor | s2 = filling valve |
| f5 = thermostat | s3 = transfer valve |
| k5 = interference suppression | A1 = actuator, upper base |
| K1 = display modul | A2 = actuator |
| K2 = control modul | l4 = aqua-sensor |
| K3 = time delay | x1 = code plug |
| | x2 = service-connector |

① exit according to equipment



Mat. Nr. 5600002023	
Ausg.: 02.00	S0-60/ 0358

Customer service test programme

Function	Temperature	Capacity	Time (s)	Sensor	Abbreviations
1	P		30		P = Pump
2	TR1 + TR2 till FD 7711				VF = Prefill / static
3	VF			F1	F = Fill / dynamic
4	F				U = Circulate
5	from FD 7712 U + H + TR1 + TR2				H = Heat
6	U + H + Z		120		Z = Dispenser
7	U + H	65 °C			R = Regenerate
8	U + H + R		120		D = Flush
9	P		60		A = Outlet (only by heat exchanger)
10	D + A		60		TR1+TR2 = Calibration of turbidity sensor
11	P + A		30		

To select the test programme press and hold the S2 and S4 buttons simultaneously and switch on the appliance.

The following displays are indicated on the control panel:

- LEDs L2 and L4 flash.
- As long as the two S2 and S4 buttons remain depressed after the dishwasher has been switched on, an identifier for the model coding is displayed when the overtravel contact has been successfully interrogated (e.g. 20 = Model 0, 21 = Model 1, etc.)
- By pressing one of the buttons, the associated LED lights up.
- By pressing the S3 button, the display and the “low level” indicator LEDs also light up.
- By pressing the time delay button, the Minutes LED lights up.

By pressing the S2 and S4 buttons, the test programme starts. Time delay programming is not possible, the test programme is ended by switching off the appliance via the main switch.

The potential fault code is displayed.

Fault code	Two 7-segment displays
0	There is no fault
1	Fault in the hydro sensor system Note: Display even if there is no sensor!
2	Heater fault
3	Fault combination Fault 1 + Fault 2
4	Filling fault
5	Fault combination Fault 1 + Fault 4
8	Fault in NTC system
9	Fault combination Fault 1 + Fault 8
10	Fault combination Fault 2 + Fault 8
F	Filling fault (is only displayed from FD7711)

The upper basket function is activated during the whole test program. The next programme step can be selected by pressing the S3 button; if the heater step is skipped, a heater fault is displayed. (Exception: Select the filling step with the F1 filling switch only).

Fault code display is in the customer service test programme only!

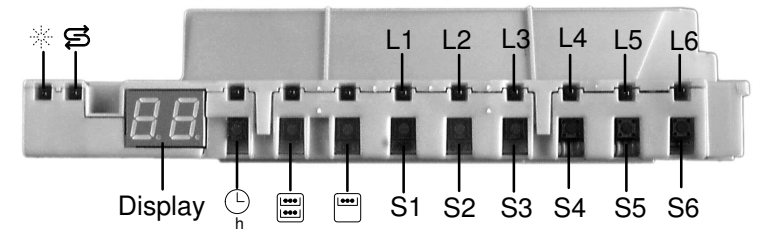
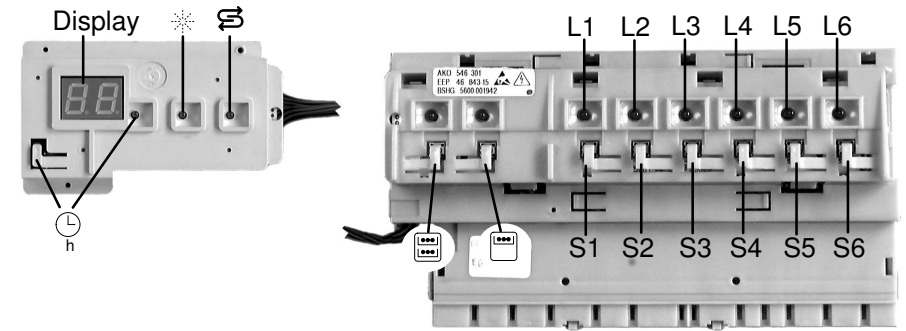

1 739 911 152	Issued: 09.00
	S0-60/0343