

1 2 3 4 5 6 7 8 9 10 11 12 13 14 15 16 17 18 19 20
Stromfad

- A = Aktuator
- a1 = Start
- a1/1 = Hauptschalter 1
- a1/2 = Hauptschalter 2 (OKS)
- e1 = Tüerschalter
- e2/3 = Reedschalter
- e5 = Sicherheitsschalter
- e6 = Schwimmerschalter
- f0 = Wasserstandregler
- f1 = Wasserstandregler
- f2 = Temperaturregler
- f3 = Temperaturregler
- f4 = Temperaturregler
- f5 = Temperaturregler
- h1/1 = Kontrollleuchte
- h1/2 = Kontrollleuchte
- h2/3 = Mangelanzeige
- k2 = Entstoerung
- k3 = Entstoerung
- m1 = Steuergeraetemotor

- 17
 - 19
 - 2
 - 2
 - 5/6
 - 5/6
 - 6
 - 6
 - 10
 - 10
 - 11
 - 15
 - 14
 - 12
 - 6
 - 3
 - 2
 - 6/5
 - 1
 - 20
 - 13
- Stromfad

- m2 = Umweltpumpe
- m3 = Pumpe entleeren
- r1 = Heizung
- s1 = Regenerierventil
- s2 = Fuellventil
- s3 = Auslaufventil
- uK = Steuergeraetemotor
- ZV = Vorwahluhr

IG 669.0B
IG 669.0W-Φ
IG 669.0J

Relaismotor

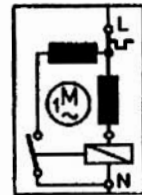

Kondensatormotor

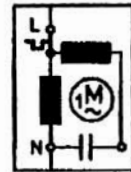

ab FD 7410-7412

Wahlschalter 1737 200 513

- b1 Vorpuelen Neuwahl: b1+b2
- b2 Glaeser 40° Test: b4+b5
- b3 Schnell 55° Tasten geloeset:
- b4 Economie 55° Normal 65°
- b5 Normal 65°
- b6 Stark 70°

Steuergeraet: *weiße Walze*
1737 203 884



1 739 911 035	Ausg.: 08/94
	60-80/0212

(Weiße Walze)
Steuergeraet

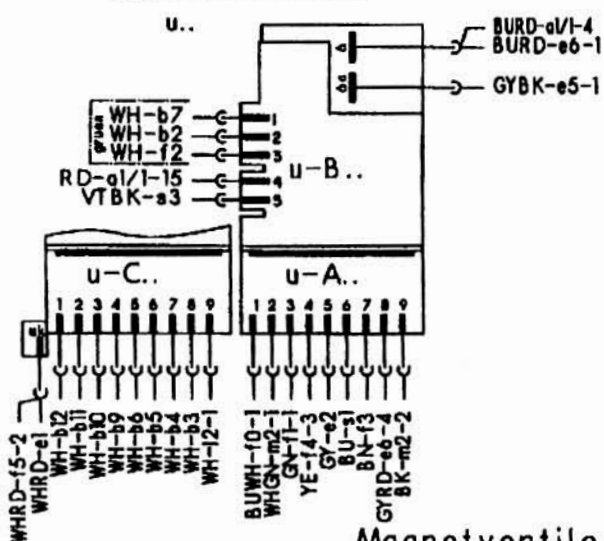

Aktuator

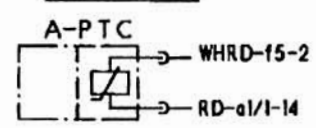

Entstoeung

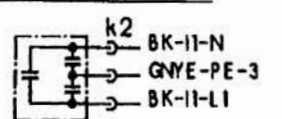

Kondensator

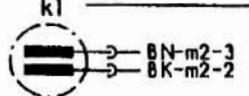

Magnetventile

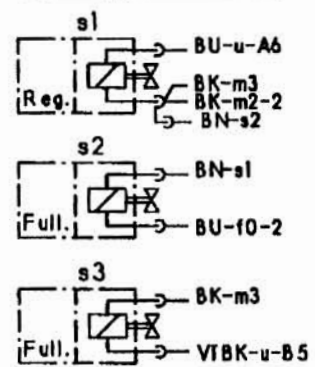

Schutzleiter

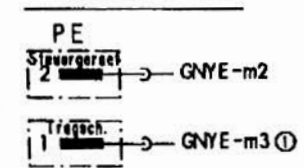

Tuerschalter

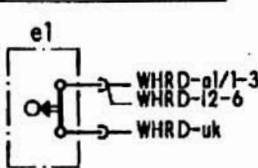

Temperaturregler

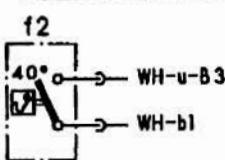

Laugenpumpe

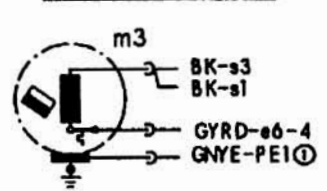

Zeitvorwahl, Salz- u. Klarspueleranz.

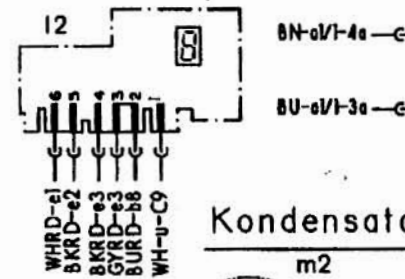

Kondensatormotor

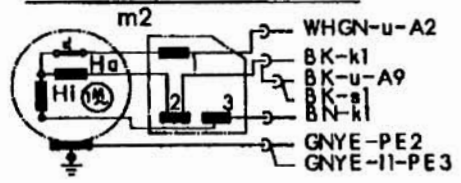

① nur bei Laugenpumpe mit Erdung

Reedschalter

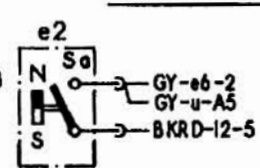

Wasserstandsregler

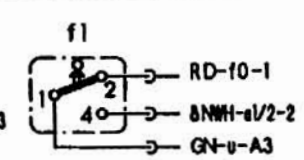

Heizung

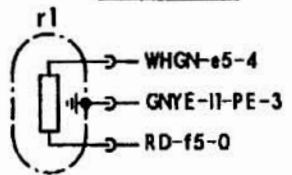

Klemme 11

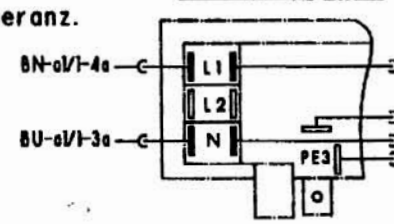

Schwimmersch.

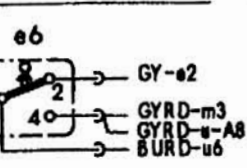

Temperaturregler

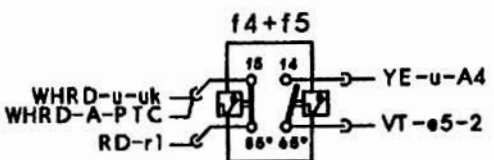

Haupt- und Wahlschalter

(1 737 200 513)

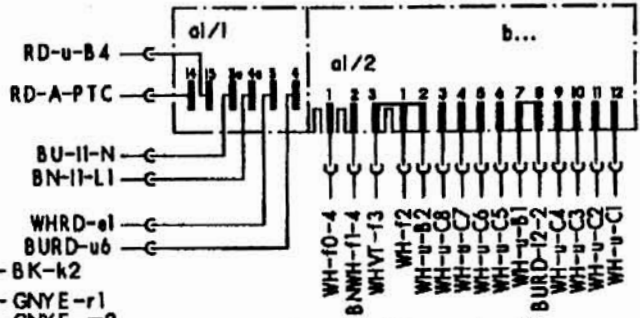

Sicherheitsschalter

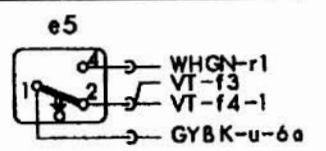

- BK = black = schwarz
- BN = brown = braun
- RD = red = rot
- YE = yellow = gelb
- GN = green = gruene
- BU = blue = blau
- VT = violet = violett
- GY = grey = grau
- WH = white = weiss
- PK = pink = rosa

bis FD 7412 Steuergeraet:
ab FD 7410 - 1737 203 884

1 739 911 036	Ausg.: 07/94
	SO-50/0216



Programmuebersicht		Programmkontakte - U		Vorspuelen		Reinigen		Zwischensp.		Karspuelen		Trocknen	
Position	Vorgang	ZEIT IN SEK.	1	2	3	4	5	6	7	8	9	10	11
1	Prüfposition	2,5°											
2	ZV	(2,5°)											
3	P	17,5°											
4	F	10/11/12,5°											
5	A+U	57,5°											
6	U	2°											
7	H+U	12+2,5°											
8	U	117,5°											
9	U	2°											
10	U	2°											
11	U	2°											
12	U	2°											
13	U+F	60°											
14	U+P	30°											
15	P	30°											
16	F	10/11/12,5°											
17	A+U	57,5°											
18	H+U	60°											
19	H+U	12+2,5°											
20	H+U	13+2,5°											
21	H+U	14+2,5°											
22	H+U	52,5°											
23	U	10°											
24	U	2°											
25	U	2°											
26	F+U	2°											
27	U	60°											
28	P+U	30°											
29	P	30°											
30	F	10/11/12,5°											
31	A+U	117,5°											
32	U	60°											
33	P+F	60°											
34	F	10/11/12,5°											
35	A+U	117,5°											
36	H+U	2°											
37	H+U	2°											
38	U	2°											
39	U	4°											
40	P+F	60°											
41	F	10/11/12,5°											
42	A+U	57,5°											
43	Req. H+U	60°											
44	H+U	13+2,5°											
45	Req. H+U+K	57,5°											
46	H+U	14+2,5°											
47	U	57,5°											
48	H+U	60°											
49	T	2°											
50	F	30°											
51	T	30°											
52	T	30°											
53	P+A	60°											
54	F	30°											
55	P	30°											
56	P	30°											
57	P	30°											
58	P	30°											
59	P	30°											
60	AUS	2,5°											

- A = Auslaufen
- F = Füllen
- H = Heizen
- K = Kiarspülerzugabe
- P = Pumpen
- T = Trocknen
- R = Reinigerzugabe
- U = Umwälzen
- Req = Regenrieren
- ZV = Zellvorwahl

▲ Temperaturmesspunkt
 ● Heißerfahren
 Schritzeit ca. 2,5 sec.
 Schalter kann offen
 oder geschlossen sein
 ② nur bei Zellvorwahl

Programmuebersicht	
Vorspuelen	
Gläser 40°C	
Schnell 55°C	
Economic 55°C	
Normal 65°C	
Stark 70°C	

Steuengeräet: *blaue Walze*
 1737 203 884 , 885

1739 911 042	Ausg.: 09/94
06FD 7501	Se-8010222



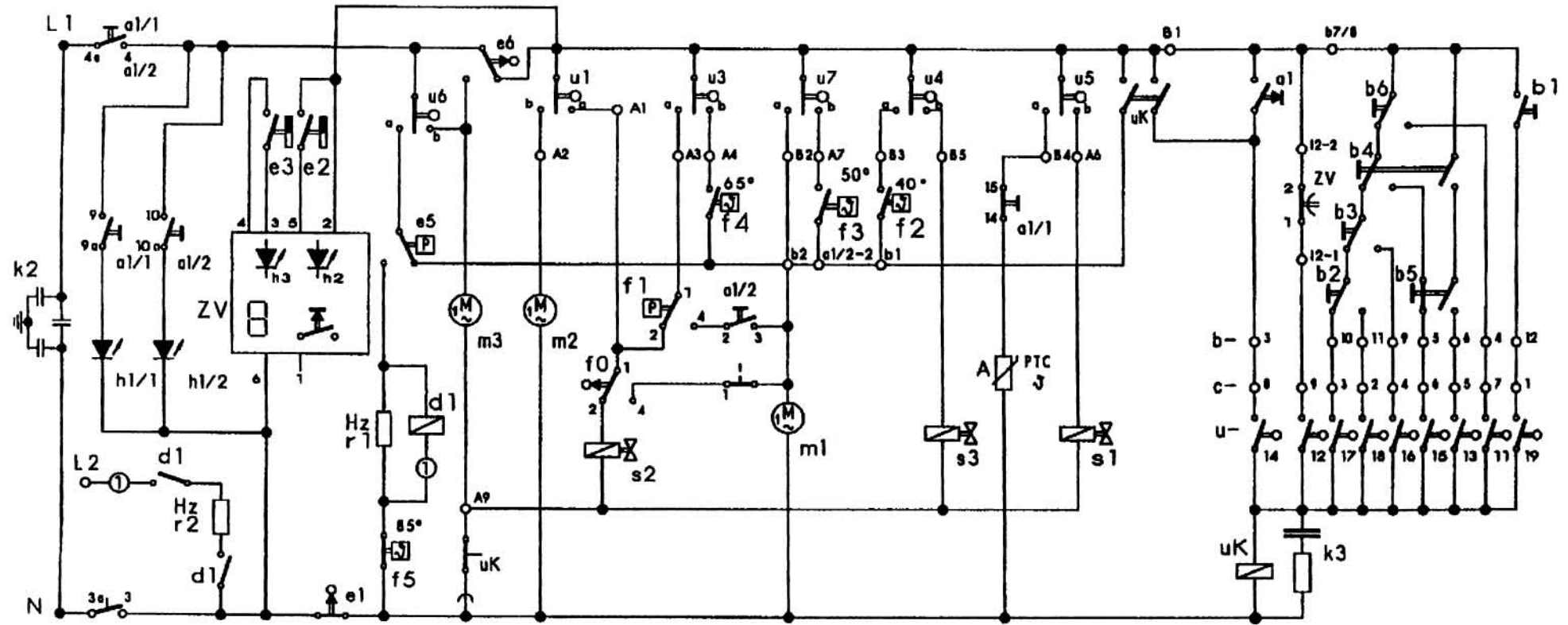

- 1 2 3 4 5 6 7 8 9 10 11 12 13 14 15 16 17 18 19 20
Strompfad
- A = Aktuator
 - a1 = Start
 - a1/1 = Hauptschalter 1
 - a1/2 = Hauptschalter 2 (OKS)
 - e1 = Tüerschalter
 - e2/3 = Reedschalter
 - e5 = Sicherheitschalter
 - e6 = Schwimmerschalter
 - f0 = Wasserstandsregler
 - f1 = Wasserstandsregler
 - f2 = Temperaturregler
 - f3 = Temperaturregler
 - f4 = Temperaturregler
 - f5 = Temperaturregler
 - h1/1 = Kontrollleuchte
 - h1/2 = Kontrollleuchte
 - h2/3 = Mangelanzeige
 - k2 = Entstoerung
 - k3 = Entstoerung
 - m1 = Steuergeraatemotor

- m2 = Umwälzpumpe
- m3 = Pumpe entleeren
- r1 = Heizung
- s1 = Regenerierventil
- s2 = Fuelventil
- s3 = Auslaufventil
- uK = Steuergeraatemotor
- ZV = Vorwahluhr

Strompfad

① nur bei 2 Phasenanschluss

Relaismotor

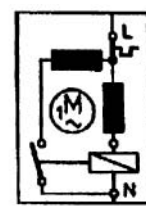

Kondensatormotor

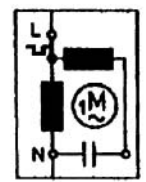

Wahlschalter 1737 200 513

- b1 Vorspulen Neuwahl: b1+b2
- b2 Glasser 40° Test: b4+b5
- b3 Schnell 55° Tasten geloeset:
- b4 Economic 55° Normal 65°
- b5 Normal 65°
- b6 Stark 70°

Steuengerat: *blaue Walze*
1737 203 884.886

IG 669.0B
IG 669.0W-0 (D)
IG 669.0J

1 739 911 048	Ausg.: 09/94
ab FD 7501	SO 00/0227

(blaue Walze)
Steuergeraet

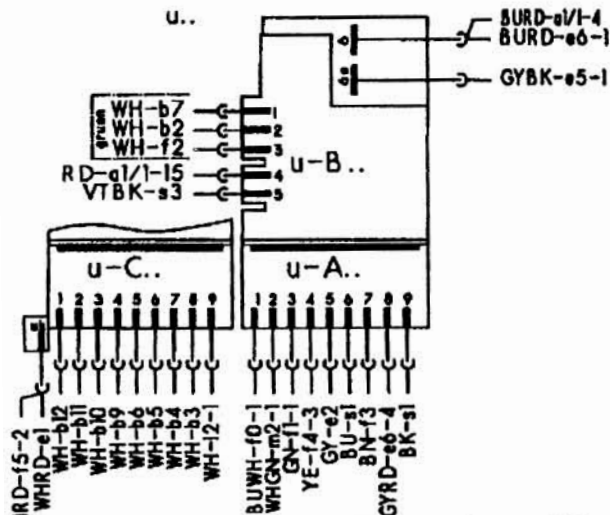

Tuerschalter

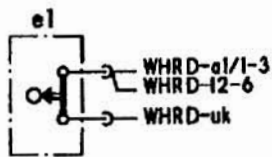

Temperaturregler

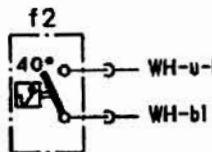

Laugenpumpe

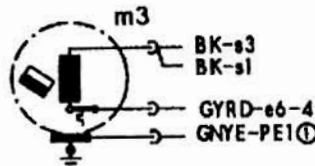

Zeitvorwahl,
Salz- u. Klarspueleranz.

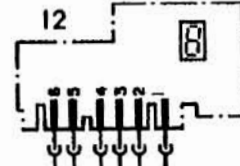

Kondensatormotor

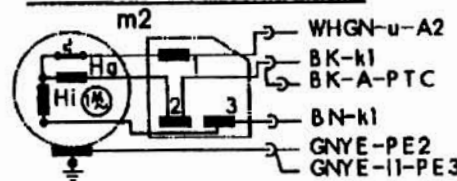

① nur bei Laugenpumpe mit Erdung

Reedschalter

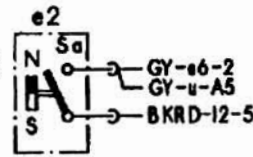

Wasserstandsregler

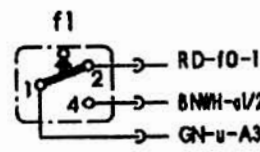

Heizung

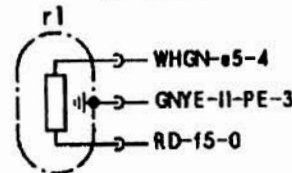

Klemme II

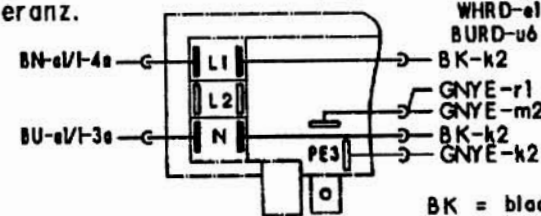

- BK = black = schwarz
- BN = brown = braun
- RD = red = rot
- YE = yellow = gelb
- GN = green = gruen
- BU = blue = blau
- VT = violet = violett
- GY = grey = grau
- WH = white = weiss
- PK = pink = rosa

Schwimmersch.

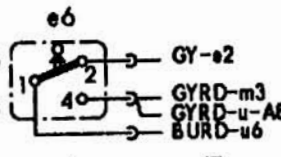

Wasserstandsregler

Wasserstands.

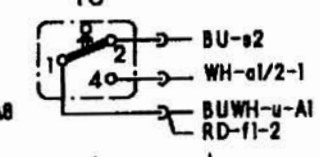

Temperaturregler

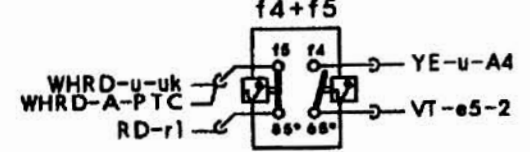

Haupt- und Wahlschalter

(1737200513)

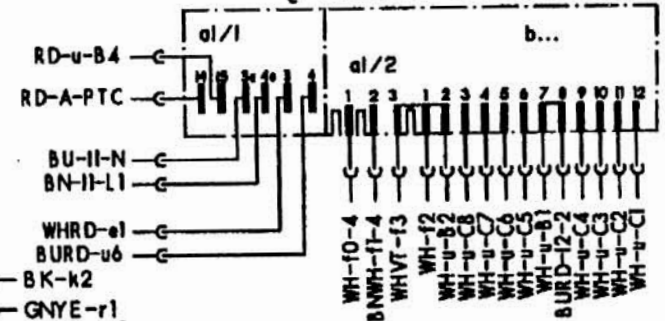

Sicherheitsschalter

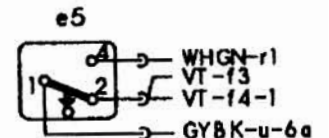

Steuergeraet:
1737 203 884

1 739 911 050	Ausg.: 09/94
ab FD7501	SO-60/0229



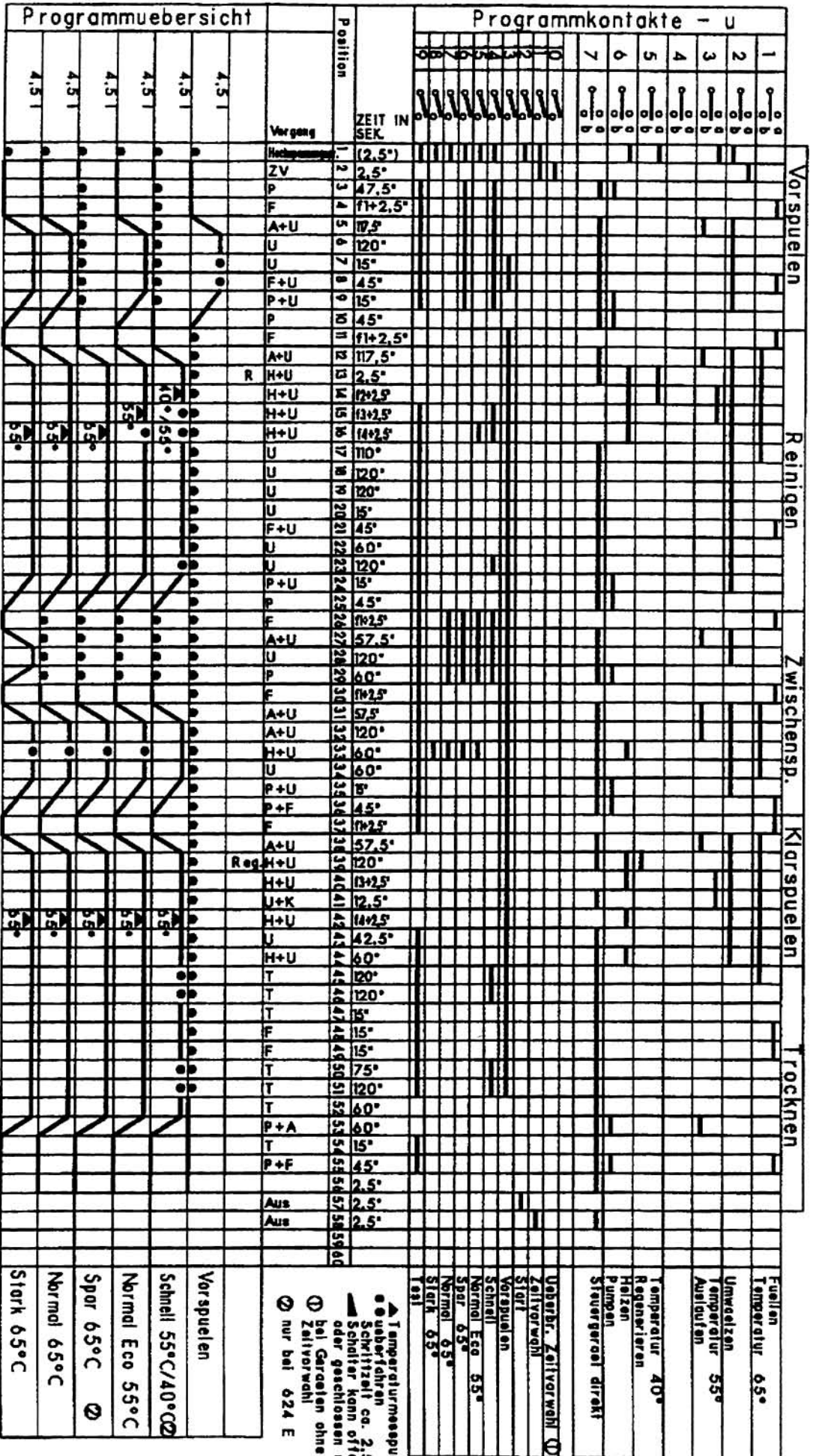

1G 659.0B
 1G 659.0W-Φ
 1G 659.0J



1 739 911 081	Ausg.: 02/95
06 TD 7504	SO 600262