

Mat. Nr. 5600042328	
Ausg.: 01.01	S0-60/ 0598

sequence timer

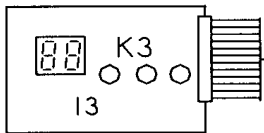

main switch

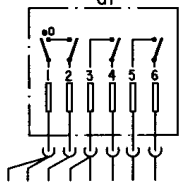

water points

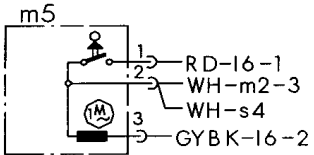

float switch

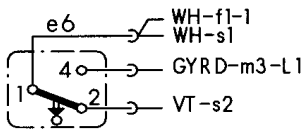

terminal I1 with interference suppression

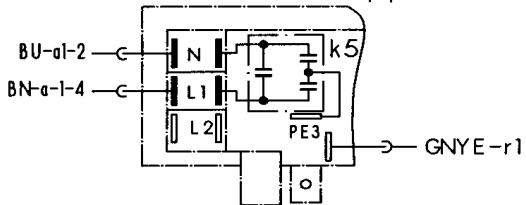

on-off and selector switch

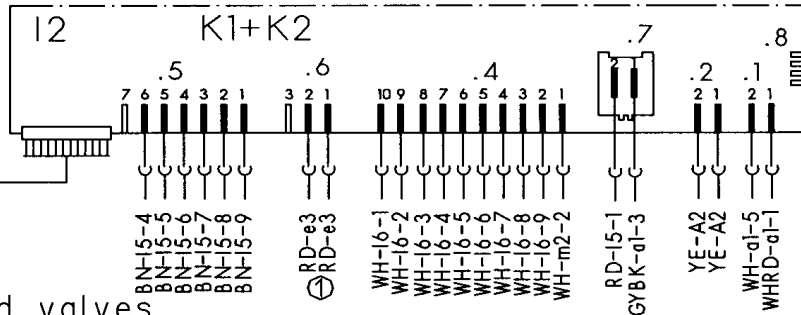

solenoid valves

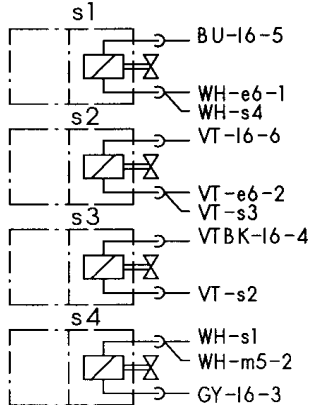

level switch

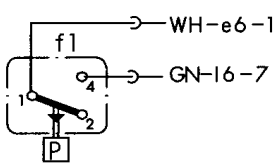

thermostat + NTC

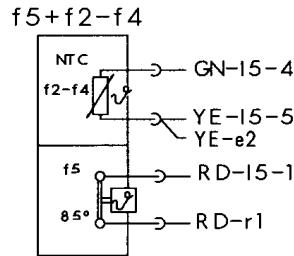

PTC-motor

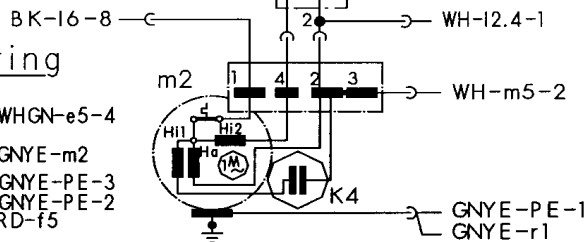

heating

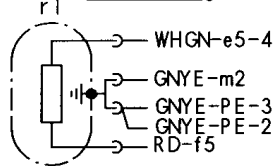

aktuator

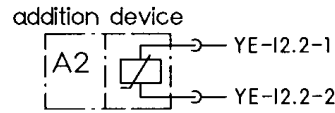

starter-PTC

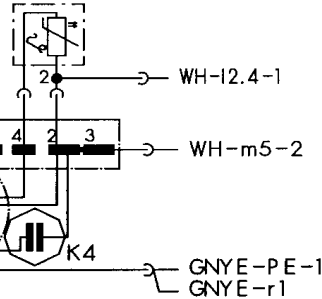

safety switch

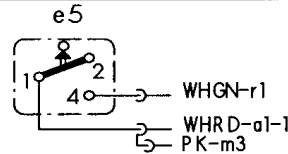

sensor

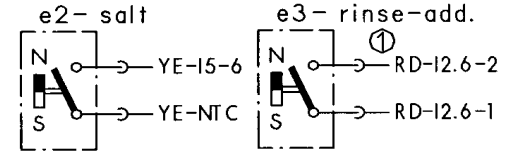

aqua-sensor

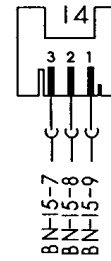

earth terminal



clutch

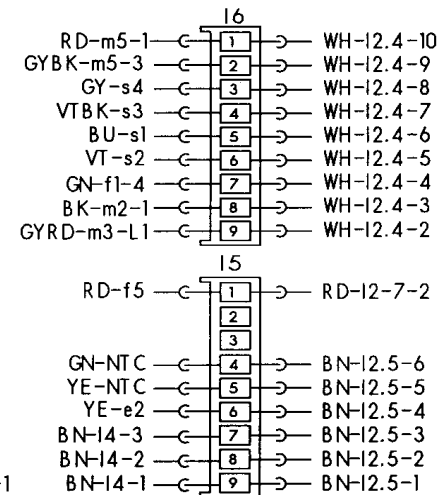

drain pump

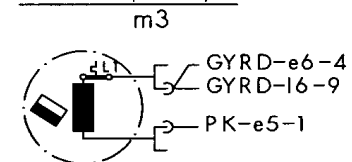

⊕ exist according to equipment
 (.) previous color



Mat.Nr.:	5600042327
Ausg.:	01.01
	SO-60/ 0599

Customer service test programme

Function	Temperature	Capacity	Time (s)	Motor lock	Sensor	Abbreviations
1	P		15	closed		P = Pump
2	VF				F1	VF = Prefill
3	F	3.9				F = Fill
4	U + H + ZR	max. 72 °C	120			U = Circulate
5	U + H	65 °C				H = Heat
6	U + H + R	max. 72 °C	120			ZR = Dispenser
7	AS_KAL_IR		0 - 480			R = Regenerate
8	P		60			FWW = Flush
9	FWW + AWT		60			AWT = Outlet
10	P + AWT		30	open		AS_KAL_IR = Calibration of turbidity sensor

To select the test programme press and hold the S2 and S4 buttons simultaneously and switch on the appliance.

The following displays are indicated on the control panel:

- LEDs L2 and L4 flash.
- As long as the two S2 and S4 buttons remain depressed after the dishwasher has been switched on, an identifier for the model coding is displayed when the overtravel contact has been successfully interrogated (e.g. 20 = Model 0, 21 = Model 1, etc.)
- By pressing one of the buttons, the associated LED lights up.
- By pressing S3 button, the display shows "188", the SALT, Rinse aid and prog. LED's are lit. The buzzer will also sound.
- By pressing the timer programming button, an 18h on the segment display light up.

By pressing the S2 and S4 buttons, the test programme starts. Timer programming is not possible, the test programme is ended by switching off the appliance via the main switch.

The potential fault code is displayed.

Fault code	Description
0	There is no fault
1	Fault in the hydro sensor system Note: Display even if there is no sensor!
2	Heater fault
4	Filling fault
8	Fault in NTC system
16	Water switch cannot be positioned
32	Motor lock switch Note: Display even if there is no motor lock!

If more than one fault is detected, the fault code is added up. (f.ex.: fault code 3 = fault 1 + fault 2)

If neither of the two special function buttons is selected, alternating rinsing has been set. If the soak/top basket special function is selected, the water switch has been positioned for top basket. If the time reduction/ bottom basket special function is selected, the water switch has been positioned for bottom basket.

The next programme step can be selected by pressing the S3 button; (Exception: Select the filling step with the F1 filling switch only).

Fault code display is in the customer service test programme only!

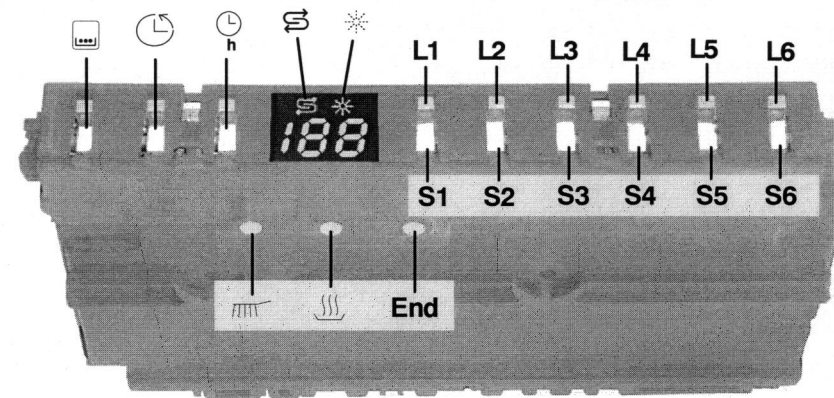

5600 038 483	Issued: 04.01
V m. WT, GV634	S0-60/0541

Coding instructions for electronics module

After replacing the electronic controls (standard installation), the control must be recoded with the appliance programmes (see table).

Note: In the case of appliances with 5 or 6 programmes/buttons the control must be programmed before the control panel frame is attached.

1. Selection:

Simultaneously press and hold down the S2, S3, S4 and S5 buttons and press the main switch. As long as the S2 to S5 buttons remain depressed, the L2 to L5 LEDs flash.

When the S2 to S5 buttons are released, the current coding is displayed (see code table).

2. Selecting the model:

The various model codings can be selected by pressing the S2 button (see table).

3. Storing the coding:

The new model / coding is stored by switching off the appliance.

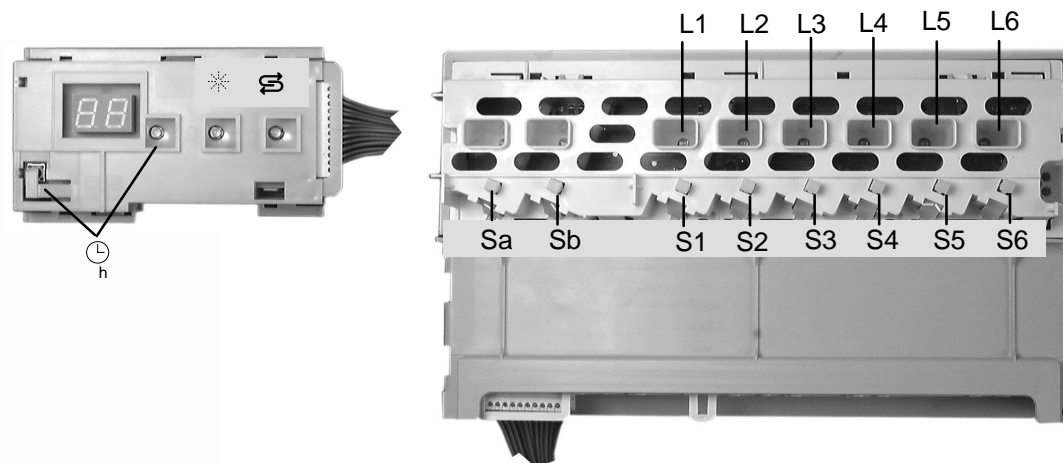











Code table:

Sa	Sb	S1	S2	S3	S4	S5	S6	electronic setting of the rinsing agent	Display
Soak	Time reduction	Intensive 70°	auto 55° / 65°	ECO 50°	Gentle 40°	Quick wash 35°	Pre-rinse	–	0
Soak	Time reduction	Intensive 70°	auto 55° / 65°	ECO 50°	Quick wash 35°	Pre-rinse		–	1
Top basket	Bottom basket	Intensive 70°	auto 55° / 65°	ECO 50°	Gentle 40°	Quick wash 35°	Pre-rinse	–	2
Top basket	Bottom basket	Intensive 70°	auto 55° / 65°	ECO 50°	Quick wash 35°	Pre-rinse		–	3
Soak	Time reduction	Intensive 70°	auto 55° / 65°	ECO 50°	Gentle 40°	Quick wash 35°	Pre-rinse	X	4
Soak	Time reduction	Intensive 70°	auto 55° / 65°	ECO 50°	Quick wash 35°	Pre-rinse		X	5
Top basket	Bottom basket	Intensive 70°	auto 55° / 65°	ECO 50°	Gentle 40°	Quick wash 35°	Pre-rinse	X	6
Top basket	Bottom basket	Intensive 70°	auto 55° / 65°	ECO 50°	Quick wash 35°	Pre-rinse		X	7
Top basket	Soak	Intensive 70°	auto 55° / 65°	ECO 50°	Gentle 40°	Quick wash 35°	Pre-rinse	–	8
Soak	Time reduction	Intensive 70°	auto 55° / 65°	ECO 50°	Quick wash 35°	Pre-rinse		–	9

Soak: Extra pre-rinse, temperature 55 °C

Time reduction: No standard washing performance, no drying phase

Programm–Symbole:

	Intensive 70°		Quick wash 35°		Soak		Top basket
	auto 55° / 65°		Gentle 40°		Time reduction		Bottom basket
	ECO 50°		Pre-rinse		Time preselection		



5600 042 247	Issued: 01.01
	S0-60/0567