

- a1 = main switch
- e2/3 = sensors
- e6 = float switch
- f1 = level switch
- NTC = temperature sensor
- f5 = thermostat
- K1 = display modul
- K2 = control modul
- K3 = timer modul
- K5 = interference suppression
- m2 = circulation motor
- m3 = drain motor
- r1 = heating element
- e5 = pressure switch
- s1 = regenerating valve
- s2 = filling valve
- s3 = transfer valve
- A2 = actuator
- x2 = service-connector
- m5 = water switch
- I4 = aqua sensor
- s4 = raw water valve

① exit according to aequipm

GB

Mat. Nr. 5600048124	
Ausg.: 02.02	S0-60/ 0637

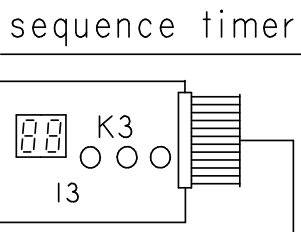
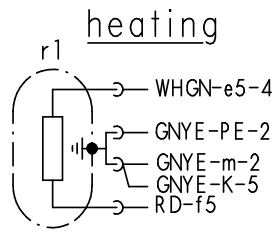

on-off and selector switch

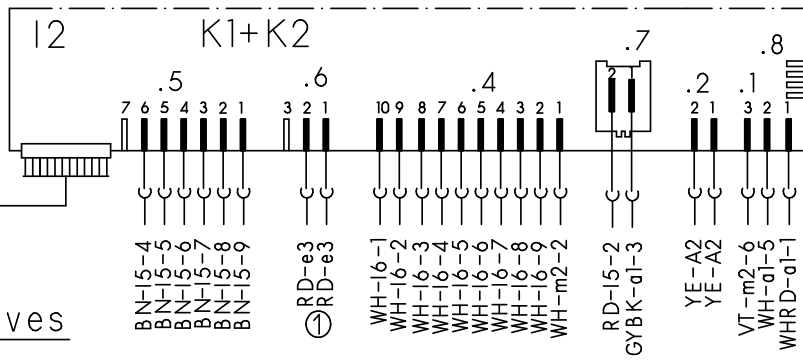

sensor

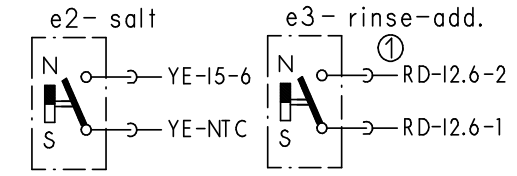

main switch

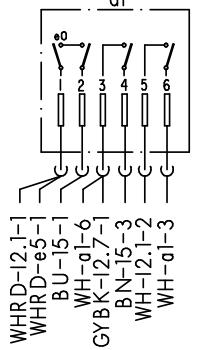

solenoid valves

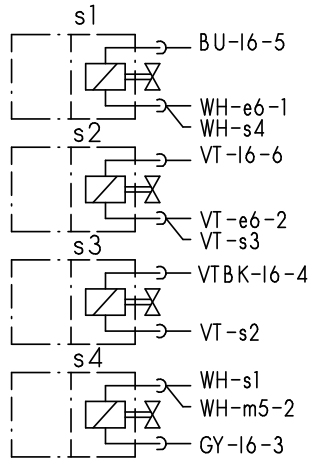

thermostat + NTC

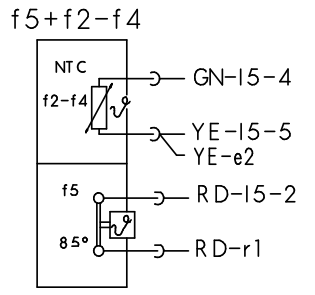

aktuator

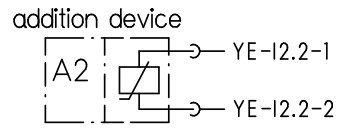

motor

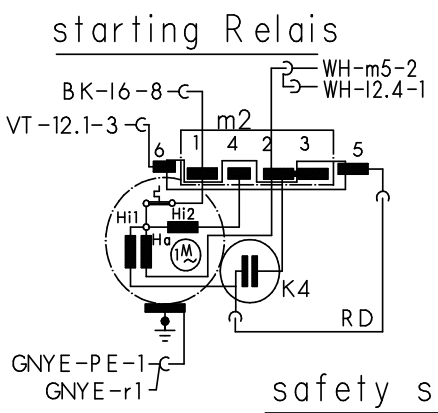

aqua-sensor

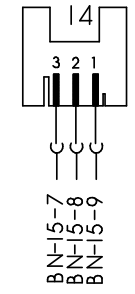

earth terminal

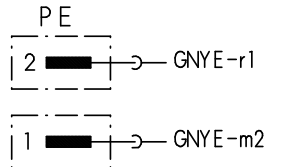

water points

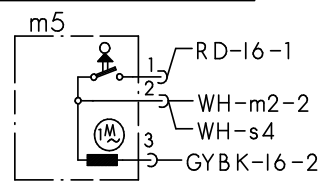

clutch

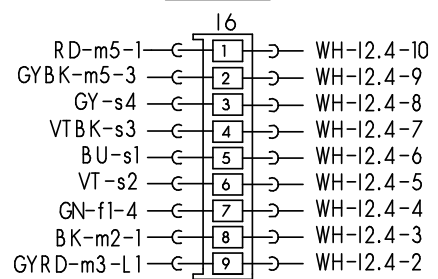

float switch

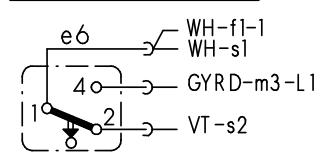

level switch

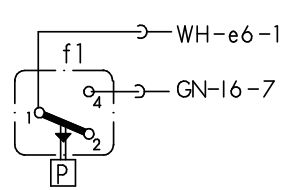

terminal I1 with interference suppression

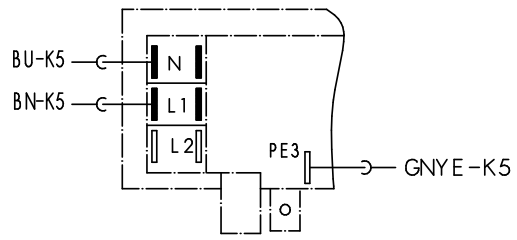

interference suppression

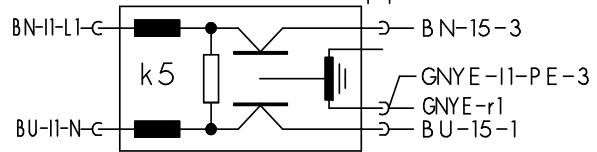

safety switch

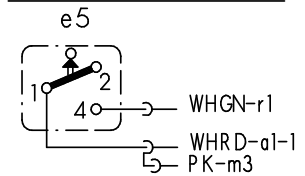

drain pump

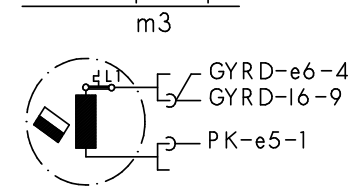

① exist according to equipment
 (..) previous color



Mat.Nr.: 5600048123	
Ausg.: 09.02	S0-60/ 0636

Customer service test programme

Function	Temperature	Capacity	Time (s)	Sensor	Abbreviations
1	P		15		P = Pump
2	VF			F1	VF = Prefill
3	F	3.9			F = Fill
4	U + H + ZR	max. 72 °C	120		U = Circulate
5	U + H	65 °C			H = Heat
6	U + H + R	max. 72 °C	120		ZR = Dispense detergents
7	U + ZK		120		ZK = Dispense rinse aid
8	AS_KAL_IR		0 – 480		R = Regenerate
9	P		60		FWW = Flush
10	FWW + AWT		60		AWT = Outlet
11	P + AWT		30		AS_KAL_IR2 = Calibration of turbidity sensor

To select the test programme press and hold the S2 and S4 buttons simultaneously and switch on the appliance.

The following displays are indicated on the control panel:

- LEDs L2 and L4 flash.
- As long as the two S2 and S4 buttons remain depressed after the dishwasher has been switched on, an identifier for the model coding is displayed when the overtravel contact has been successfully interrogated (e.g. 20 = Model 0, 21 = Model 1, etc.)
- By pressing one of the buttons, the associated LED lights up.
- By pressing the S3 button, the display and the “low level” indicator LEDs also light up.
- By pressing the timer programming button, an 8h on the segment display and the Minutes LED light up.

By pressing the S2 and S4 buttons, the test programme starts. Timer programming is not possible, the test programme is ended by switching off the appliance via the main switch.

The potential fault code is displayed.

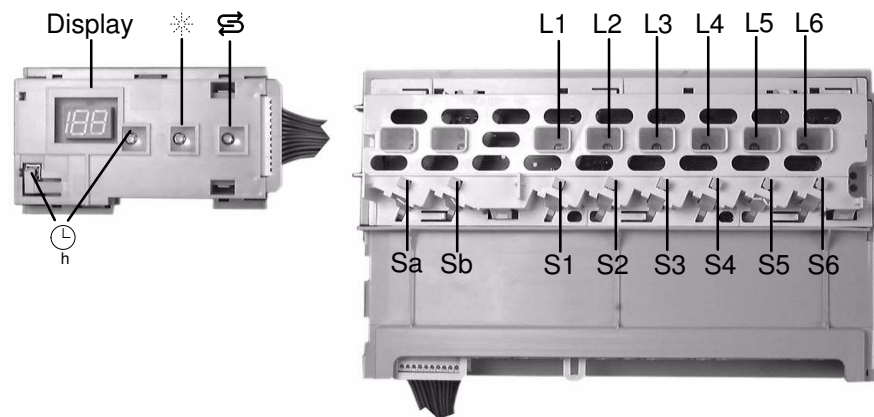

Fault code	Description
0	There is no fault
1	Fault in the hydro sensor system Note: Display even if there is no sensor!
2	Heater fault
4	Filling fault
8	Fault in NTC system
16	Water switch cannot be positioned

If neither of the two special function buttons (Sa/Sb) is selected, alternating rinsing has been set. If the soak/top basket special function is selected, the water switch has been positioned for top basket. If the time reduction/bottom basket special function is selected, the water switch has been positioned for bottom basket.

The next programme step can be selected by pressing the S3 button; (Exception: Select the filling step with the F1 filling switch only). Fault code display is in the customer service test programme only!

If more than one fault is detected, the fault code is added up. (f.ex.: fault code 3 = fault 1 + fault 2)



5600 047 455	Issued: 08.02
	S0-60/0699

Coding instructions for electronics module

After replacing the electronic controls (standard installation), the control must be recoded with the appliance programmes (see table).

Note: In the case of appliances with 5 or 6 programmes/buttons the control must be programmed before the control panel frame is attached.

1. Selection:

Simultaneously press and hold down the S2, S3, S4 and S5 buttons and press the main switch. As long as the S2 to S5 buttons remain depressed, the L2 to L5 LEDs flash.

When the S2 to S5 buttons are released, the current coding is displayed (see code table).

2. Selecting the model:

The various model codings can be selected by pressing the S2 button (see table).

3. Storing the coding:

The new model / coding is stored by switching off the appliance.

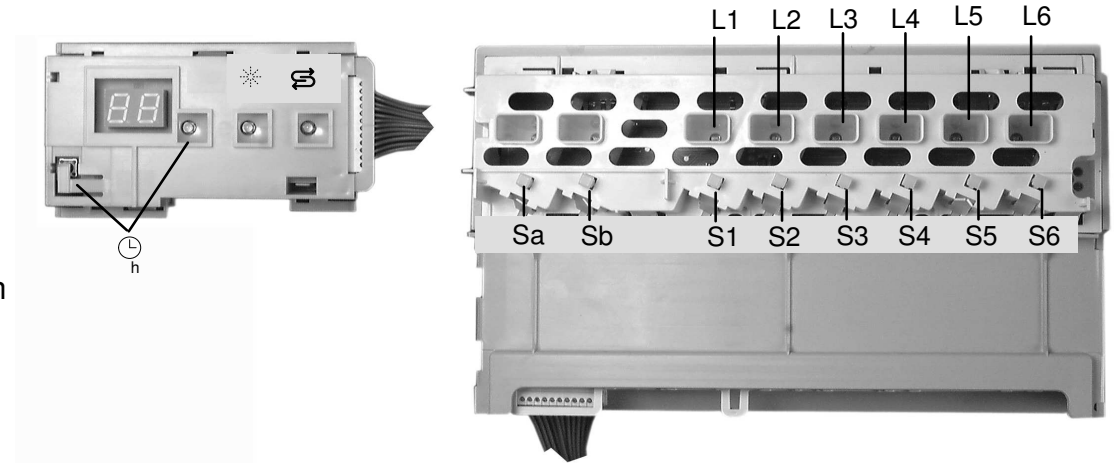











Code table:

Sa	Sb	S1	S2	S3	S4	S5	S6	Top – Dispencer	Display
Soak	Time reduction	Intensive 70°	auto 55° / 65°	ECO 50°	Gentle 40°	Quick wash 35°	Pre-rinse	–	0
Soak	Time reduction	Intensive 70°	auto 55° / 65°	ECO 50°	Quick wash 35°	Pre-rinse		–	1
Top basket	Bottom basket	Intensive 70°	auto 55° / 65°	ECO 50°	Gentle 40°	Quick wash 35°	Pre-rinse	–	2
Top basket	Bottom basket	Intensive 70°	auto 55° / 65°	ECO 50°	Quick wash 35°	Pre-rinse		–	3
Soak	Time reduction	Intensive 70°	auto 55° / 65°	ECO 50°	Gentle 40°	Quick wash 35°	Pre-rinse	X	4
Soak	Time reduction	Intensive 70°	auto 55° / 65°	ECO 50°	Quick wash 35°	Pre-rinse		X	5
Top basket	Bottom basket	Intensive 70°	auto 55° / 65°	ECO 50°	Gentle 40°	Quick wash 35°	Pre-rinse	X	6
Top basket	Bottom basket	Intensive 70°	auto 55° / 65°	ECO 50°	Quick wash 35°	Pre-rinse		X	7
Top basket	Soak	Intensive 70°	auto 55° / 65°	ECO 50°	Gentle 40°	Quick wash 35°	Pre-rinse	–	8

Soak: Extra pre-rinse, temperature 55 °C

Time reduction: No standard washing performance, no drying phase

Programm–Symbole:

	Intensive 70°		Quick wash 35°		Soak		Top basket
	auto 55° / 65°		Gentle 40°		Time reduction		Bottom basket
	ECO 50°		Pre-rinse		Time preselection		



5600 042 247	Issued: 06.06
	S0–60/0567