

on-off and selector switch

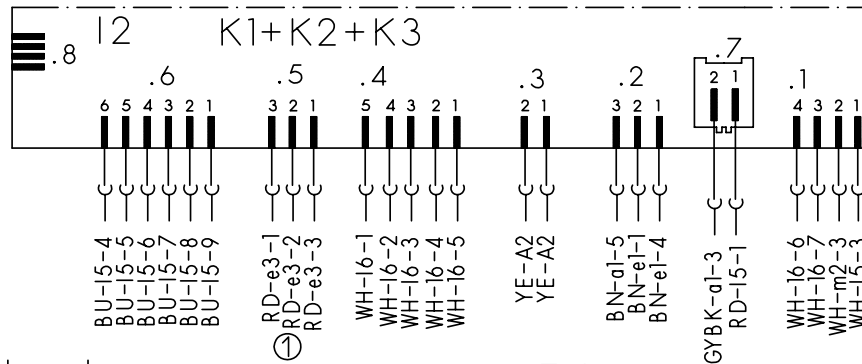

sensor

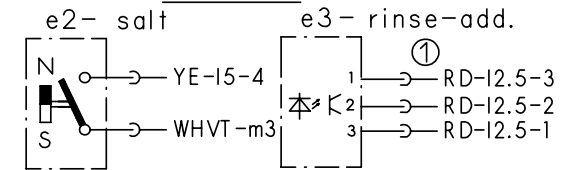

main switch

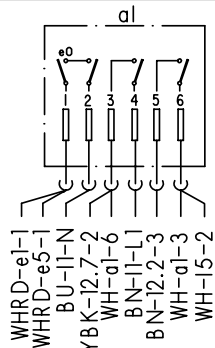

aqua-sensor

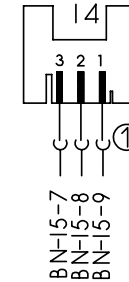

earth terminal

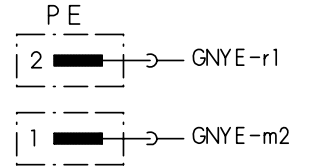

solenoid valves thermostat + NTC

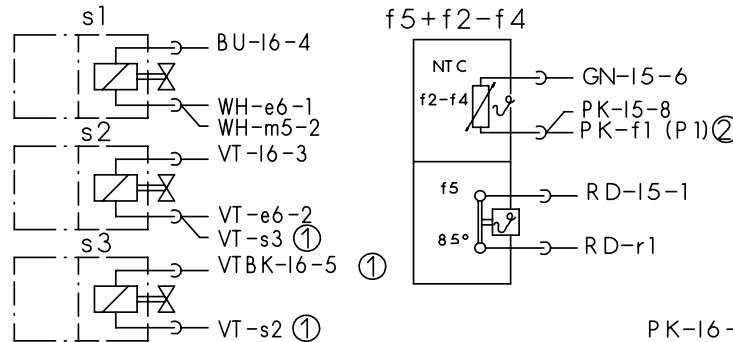

aktuator

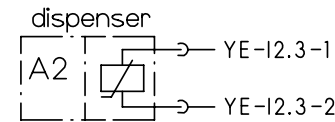

water points

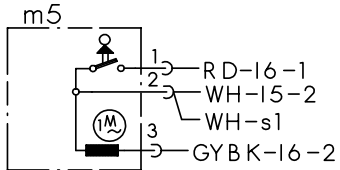

float switch

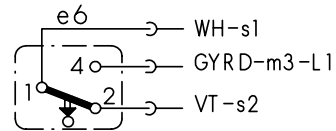

level switch

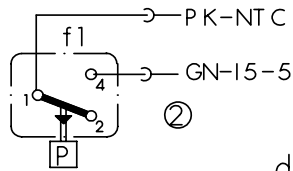

heating

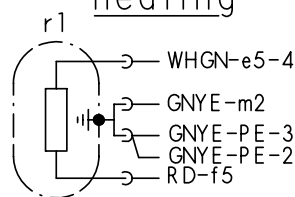

motor

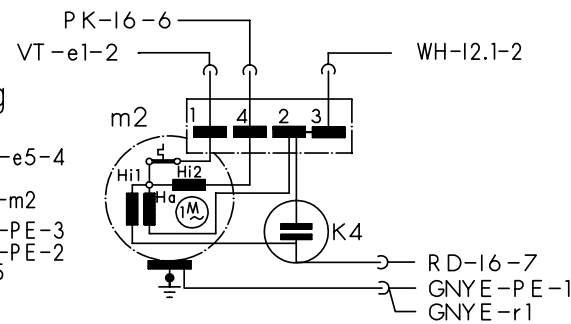

clutch

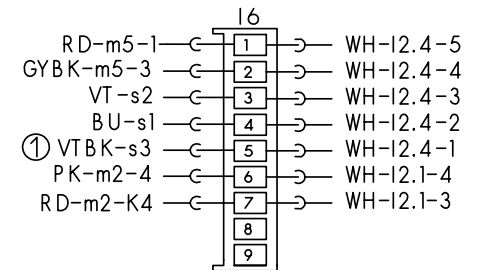

terminal I1 with interference suppression

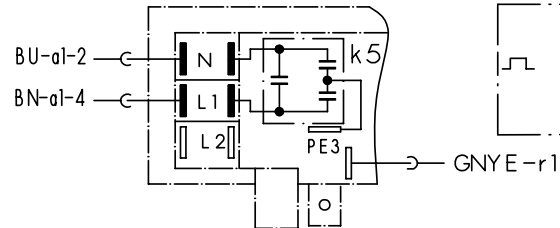

flowmeter

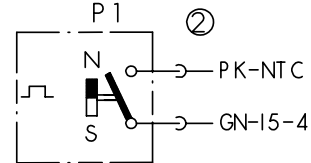

door switch

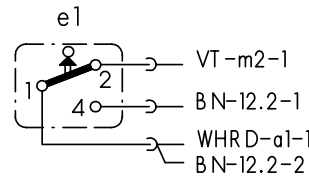

safety switch

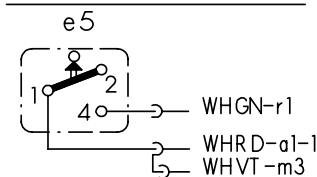

drain pump

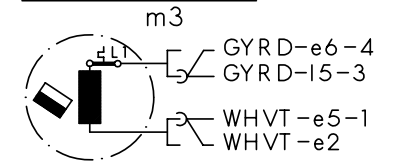

- ① exist according to equipment
- (.) previous color
- ② exist according to version



Mat.Nr.: 9000017140	
Ausg.: 04.04	S0-60/ 0894

The reproduction, transmission or use of this document or its contents is not permitted without express written authority. Offenders will be liable for damages. All rights including rights created by patent grant or registration of a utility model or design are reserved. Copyright reserved.

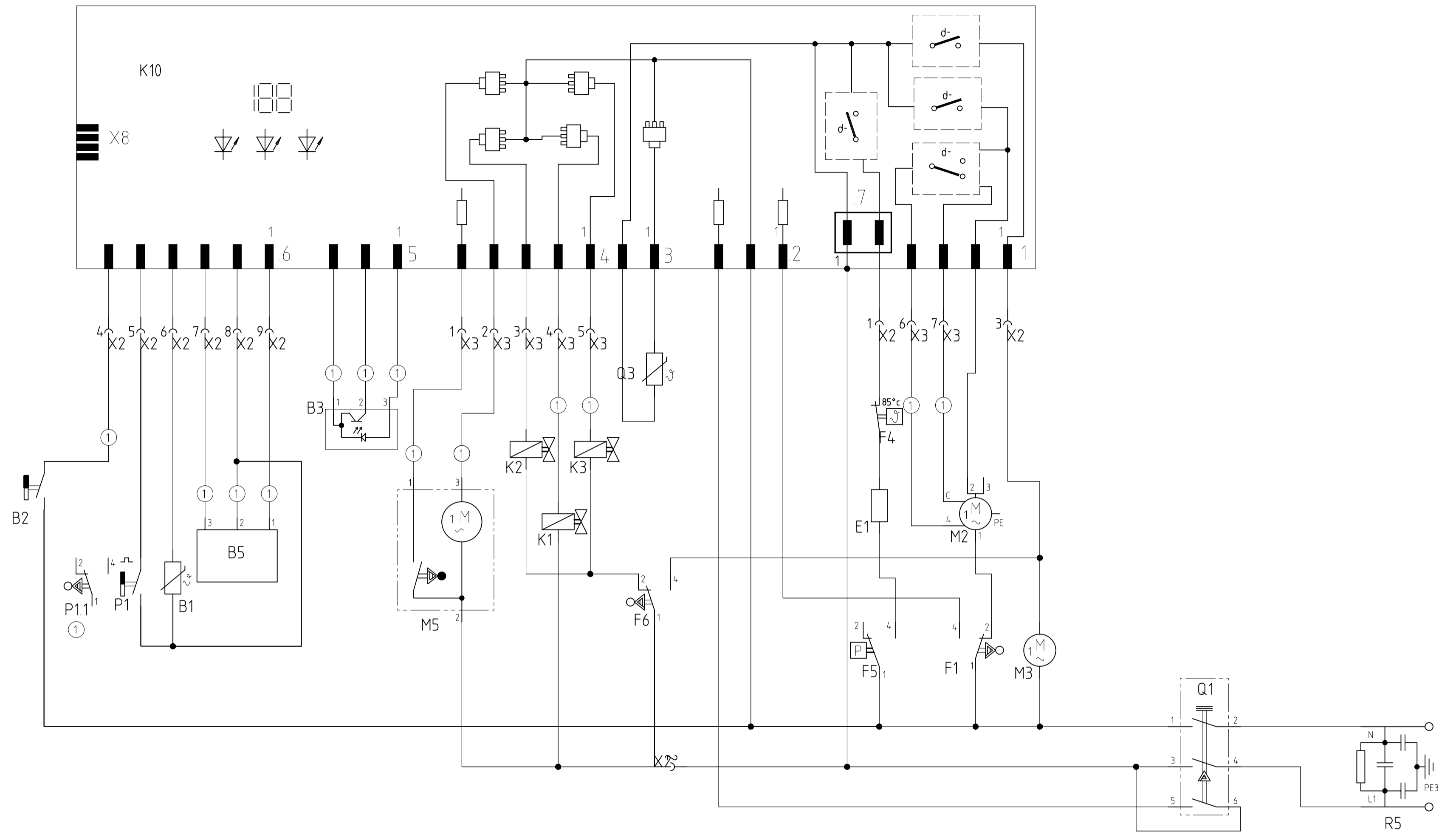

REF	Components	Path	REF	Components	Path	REF	Components	Path
B1	Temperature sensor ntc	15	F6	safety pressure switch	29-31	P11	Level switch	12,13
B2	Low salt sensor	11	K1	Regeneration valve	27	Q1	Main switch	46,48
B3	Low rinse aid sensor optical	20-22	K2	Filler valve	26	Q3	Dispenser actuator	30
B5	Aqua sensor 1	16-18	K3	Drainage valve	28	R5	Mains connection with interference suppressor	52,54
E1	Heater	37	K10	Control unit	13-18,20-22,24-30,32-34,36-41			
E1	Heater		M2	Circulation pump sicasym	39-41			
F1	Door switch	39,40	M3	Detergent solution pump	42			
F4	Safety thermostat	37	M5	Water switch	22,24			
F5	Safety pressure switch	36,37	P1	Impeller meter	14			

① Fitted depending on features