

on-off and selector switch

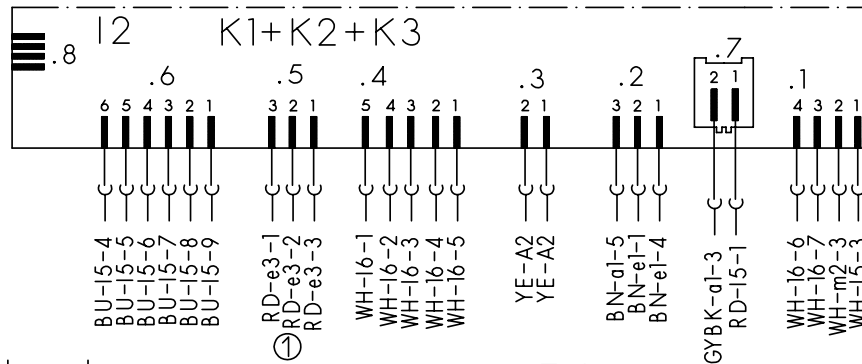

sensor

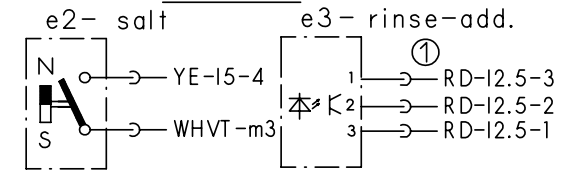

main switch

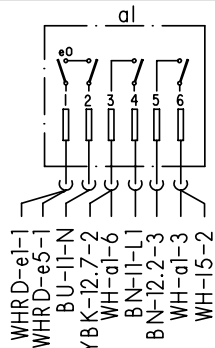

aqua-sensor

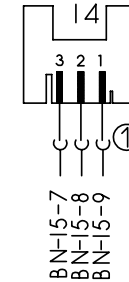

earth terminal

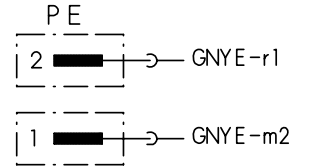

solenoid valves thermostat + NTC

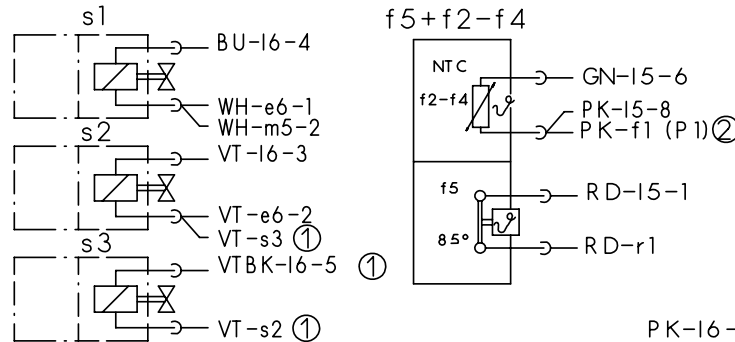

aktuator

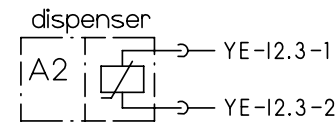

water points

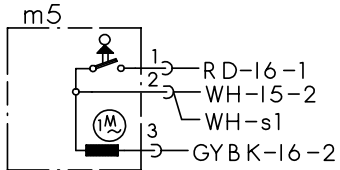

float switch

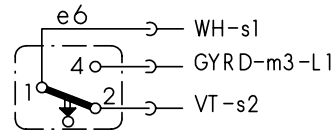

level switch

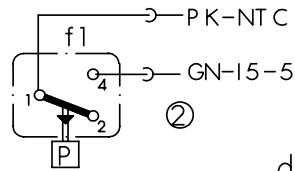

heating

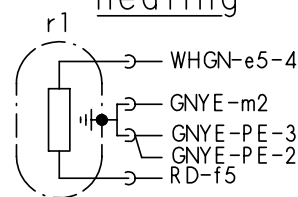

motor

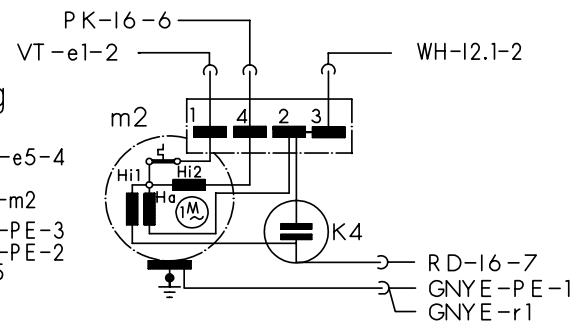

clutch

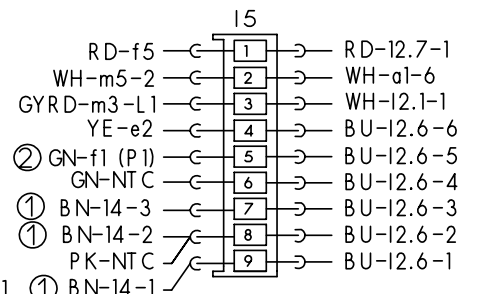
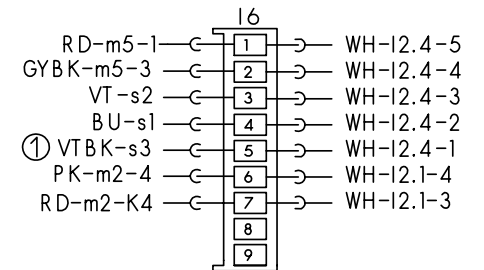

terminal I1 with interference suppression

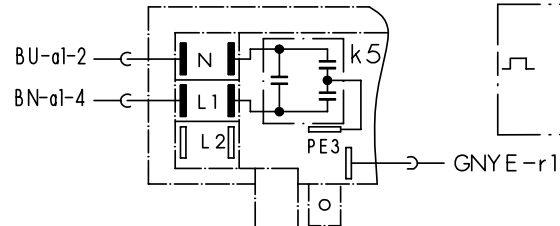

flowmeter

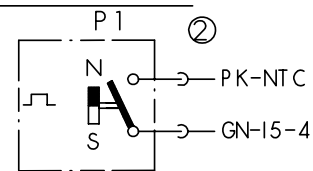

door switch

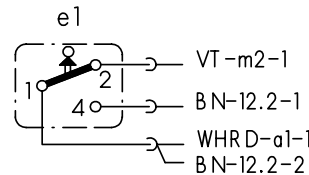

safety switch

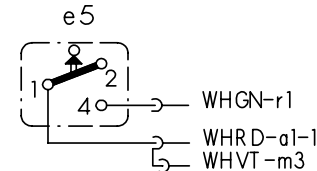

drain pump

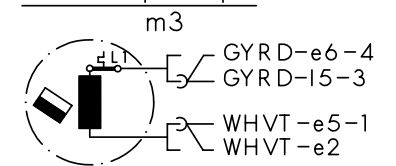

- ① exist according to equipment
- (.) previous color
- ② exist according to version



Mat.Nr.: 9000017140	
Ausg.: 04.04	S0-60/0894

The reproduction, transmission or use of this document or its contents is not permitted without express written authority. Offenders will be liable for damages. All rights including rights created by patent, grant or registration of a utility model or design are reserved. Copyright reserved.

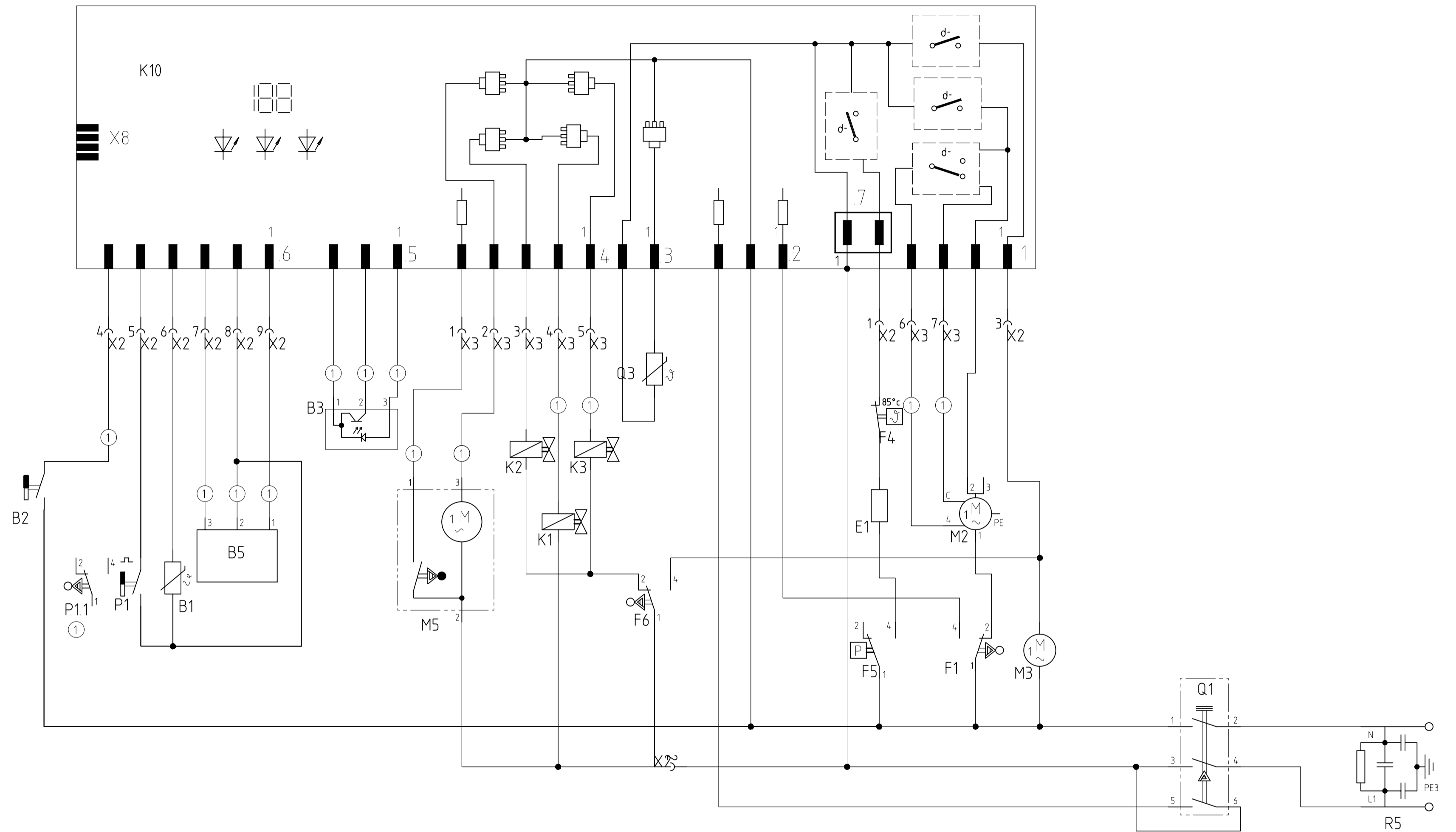

1 2 3 4 5 6 7 8 9 10 11 12 13 14 15 16 17 18 19 20 21 22 23 24 25 26 27 28 29 30 31 32 33 34 35 36 37 38 39 40 41 42 43 44 45 46 47 48 49 50 51 52 53 54 55

REF	Components	Path	REF	Components	Path	REF	Components	Path
B1	Temperature sensor ntc	15	F6	safety pressure switch	29-31	P11	Level switch	12,13
B2	Low salt sensor	11	K1	Regeneration valve	27	Q1	Main switch	46,48
B3	Low rinse aid sensor optical	20-22	K2	Filler valve	26	Q3	Dispenser actuator	30
B5	Aqua sensor 1	16-18	K3	Drainage valve	28	R5	Mains connection with interference suppressor	52,54
E1	Heater	37	K10	Control unit	13-18,20-22,24-30,32-34,36-41			
E1	Heater		M2	Circulation pump sicasym	39-41			
F1	Door switch	39,40	M3	Detergent solution pump	42			
F4	Safety thermostat	37	M5	Water switch	22,24			
F5	Safety pressure switch	36,37	P1	Impeller meter	14			

① Fitted depending on features

Customer service test programme

1. Selecting the model coding:

- Switch off the appliance
- Open door
- Hold down any two buttons and press main switch until the model coding is indicated on the display.

2. Selecting the special programme:

- Release buttons, LED L3 comes on and LED L4 flashes, P0 is displayed
- Press button S4 to acknowledge the special programme P0 (read out fault memory)

3. Reading out the fault memory:

Alternately press and release button S4 to read out the fault memory of the last 8 rinse cycles

- Press the button, the rinse cycle is displayed (00–07)
- Release the button, the associated fault is displayed (see table)

If several faults occur in a rinse cycle, only the fault with the highest value is displayed

4. Customer service test programme

- Press button S3
- Close the door, the customer service programme starts

While the customer service programme is running, each status change of the analogue signal inputs (e.g. filling switch F1) is acknowledged by the electronics module with LEDs which flash briefly. The particular programme position is indicated via the display. The water points are actuated for as long as the programme is running. The LED L4 flashes for as long as the customer service programme is running.

Switch to the next programme position with the S3 button. (Exception: during the filling step)

A fault which has occurred is indicated immediately via the display (heating fault after 60 minutes). Following each repair a customer service test programme must be run to detect any other faults

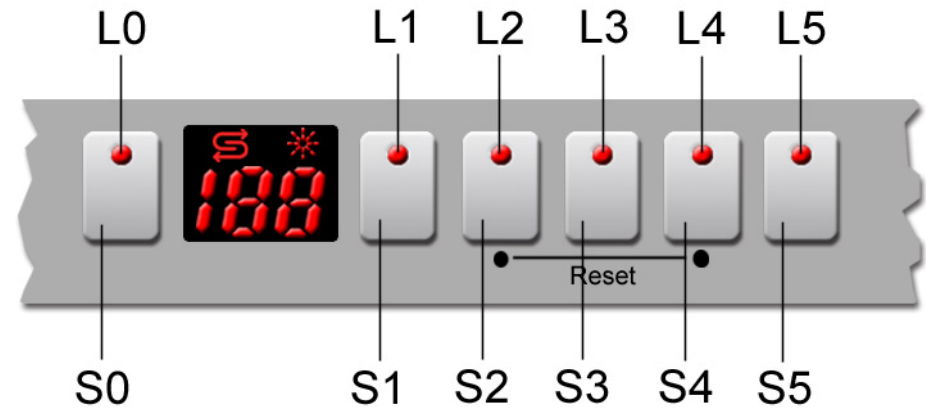

Document No. 56000000121385 ASP EN A	Rev. A	Sheet-No. 1 of 2
Material No. 9000 048 144	GV450 / GV630 , I rati , WT	

Fault code:

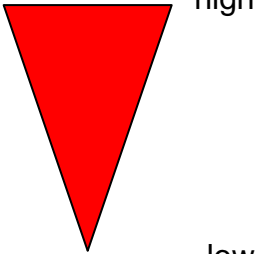
Fault code	Fault type	Value
E1	Heating fault	
E2	NTC fault	
E3	Filling fault	
E4	Water points cannot be positioned	
E5	- - -	
E6	Aqua sensor	
E7	- - -	

Sequence of the customer service test programme:

	Function	Temperature	Capacity	Time (s)	Sensor	Symbol
1	P			15		P = Pump
2	VF				F1	VF = Prefill
3	PA			5		F = Fill (level F1)
4	F + reversal relay/ auxiliary winding (SICASYM) + AWT		3.9	X + 10		U = Circulate
5	U + H + ZR	max. 72° C		120		H = Heat
6	U + H	60° C				ZR = Dispense detergent
7	U + H + R	max. 72° C		120		ZK = Dispense rinse aid
8	U + H + ZK	max. 72° C		120		R = Regeneration valve
9	AS_KAL_IR					FWW = Fill soft water
10	WP			30		AS_KAL= Calibrate Aqua sensor
11	P			45		AWT = Heat exchanger outlet valve
12	FWW + AWT			60		WP = Alternating pump
13	SP			30		SP = Intermittent pump
14	P + AWT			30		PA = Pause
0	End					X = Calculated refill time