

main switch

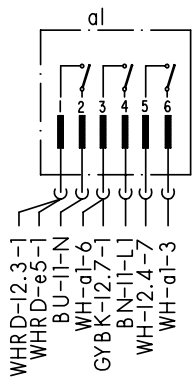

aktuator

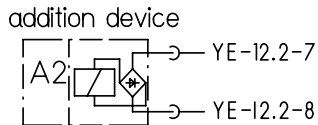

level switch

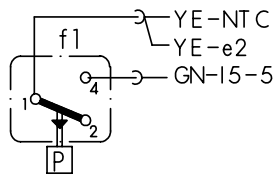

door switch

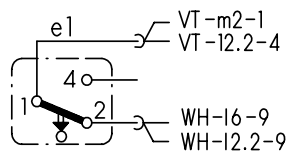

float switch

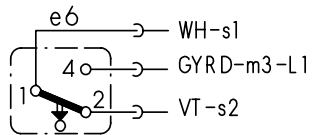

water points

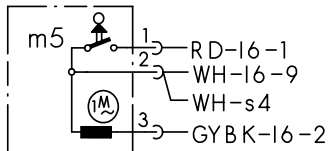

terminal I1 with interference suppression

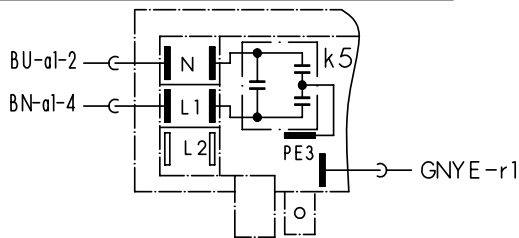

time delay, display and control unit

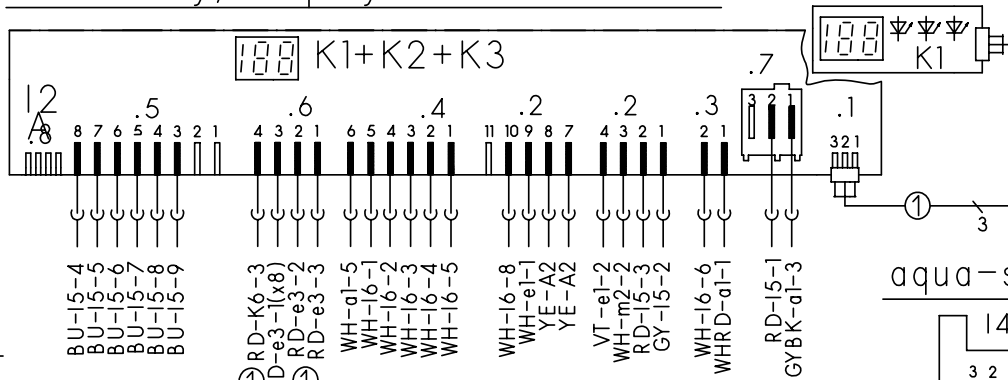

sensor

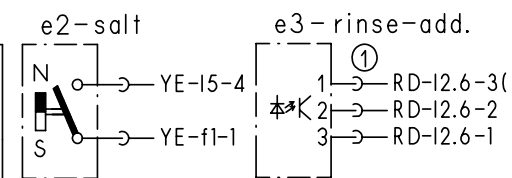

Splice ①

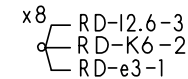

aqua-sensor

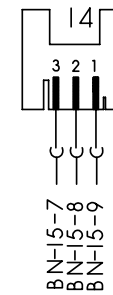

thermostat + NTC

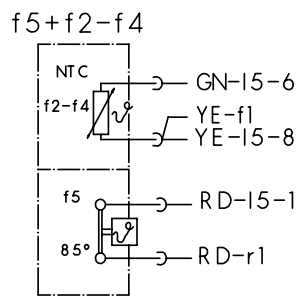

earth terminal

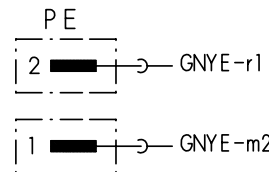

clutch

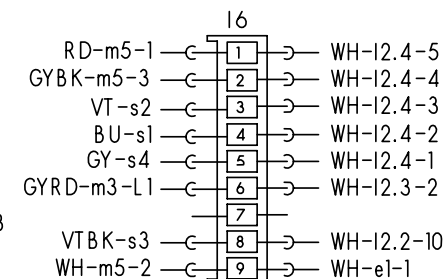

solenoid valves

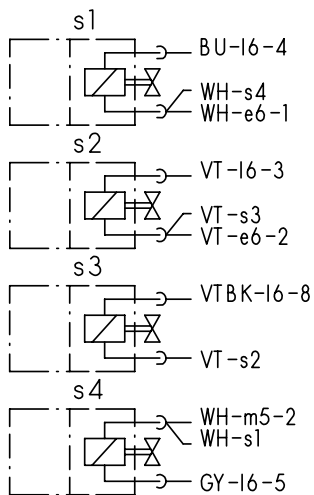

starter-PTC

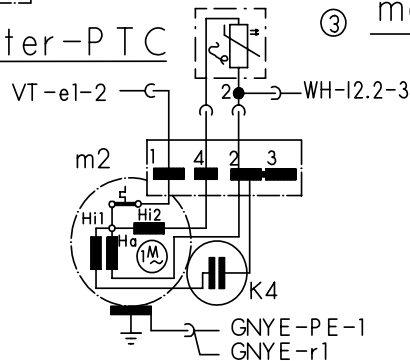

motor

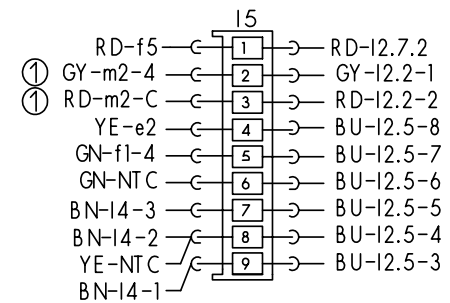
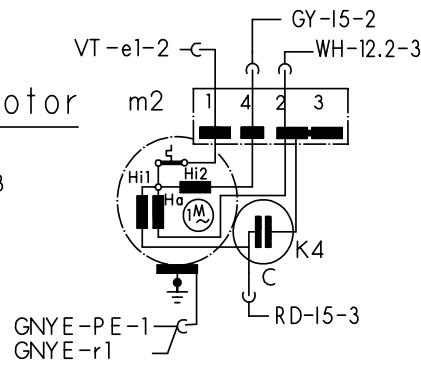

heating

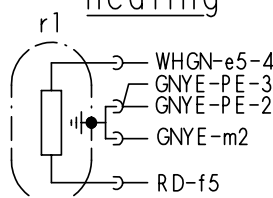

safety switch

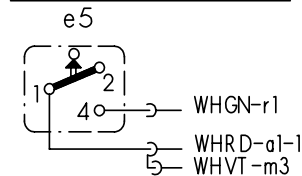

drain pump

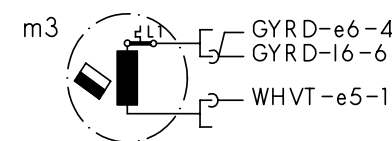

Info-Light ①

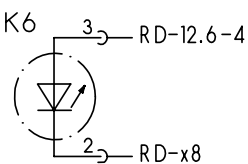

① exist according to equipment
② if exist without function
③ according to motortyp



Mat.Nr.: 9000009361	
Ausg.: 02.04	S0-60/0812

Customer service test programme

1. Selecting the model coding:

When the door is open, hold down any two buttons and press main switch until the model coding is indicated on the display.

2. Select special programme:

When the two buttons are released, LED L3 lights up and LED L4 flashes P0 is displayed. The required special programme can be selected by pressing the S3 button.

- **P0** = Read out fault memory
- **P1** = Customer service test programme
- **P2/P3** = In-plant test programmes
- **P4** = Model coding

Press S4 to acknowledge the selected programme

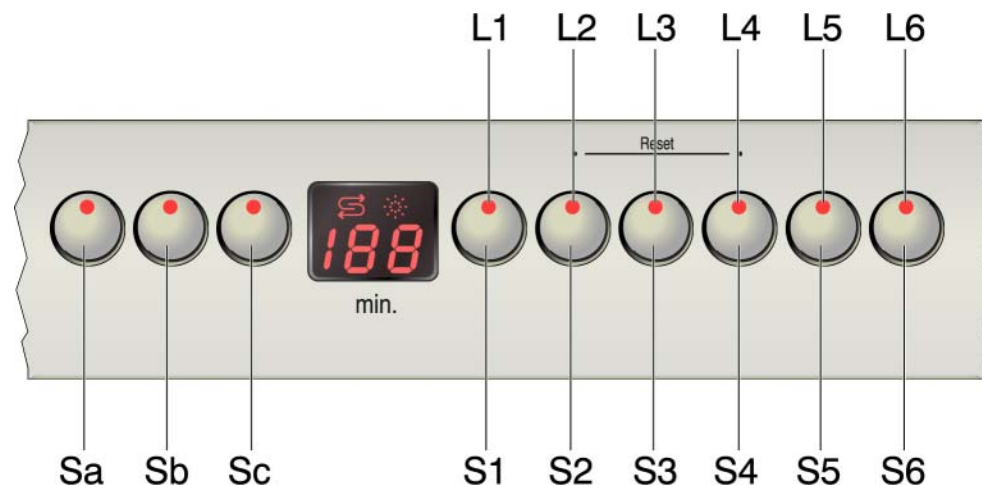

3. Read out fault memory (P0)

The faults of the last 8 wash cycles can be scanned by pressing the S4 button. When the button is pressed, the wash cycle is displayed (00–07). When the button is released, the associated fault is displayed (see table). If several faults occur in a wash cycle, only the fault with the highest value is displayed.

4. Customer service test programme (P1)

The customer service programme is started by closing the door.

Switch to the next programme position with the S3 button.

(Exception: Move to the next filling step by pressing filling switch F1 only).

Each status change of the processor inputs is acknowledged by all LEDs lighting up briefly.

A fault which has occurred is indicated immediately via the display (heating fault after 60 minutes). If several faults occur, only the fault with the highest value is displayed. Following each repair a customer service test programme must be run to detect any other faults.

Document No. 58300000019348 ASP EN B	Rev. B	Sheet-No. 1 of 1
Material No. 5600 059 979	GV636 ,V+ , WT	

5. Fault code:

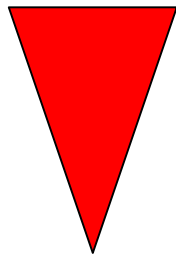
Fault code	Fault type	Value
E01	Heating fault	
E02	NTC fault	
E03	Filling fault	
E04	Water points cannot be positioned	
E05	Tachogenerator	
E06	Aqua sensor	
E07	---	

6. Sequence of the customer service test programme:

	Function	Temperature	Capacity	Time (s)	Sensor	Symbol
1	P			15		P = Pump
2	VF				VF	VF = Prefill
3	PA			5		F = Fill (level F1)
4	F		3.9			U = Circulate
5	U + H + ZR	max. 72°		120		H = Heating
6	U + H	60°				ZR = Dispense detergent
7	U + H + R	max. 72°		120		ZK = Dispense rinse aid
8	U + ZK			120		R = Regeneration valve
9	AS_KAL_IR					FWW = Fill soft water
10	WP			30		AS_KAL = Calibrate Aqua sensor
11	P			45		
12	FWW + AWT			60		
13	SP			30		
14	P + AWT			30		

Document No. 58300000019348 ASP EN B	Rev. B	Sheet-No. 2 of 2
Material No. 5600 059 979	GV636 ,V+ , WT	