

1 2 3 4 5 6 7 8 9 10 11 12 13 14 15 16 17 18 19 20 21 22 23 24 25 26 27 28 29 30 31 32 33 34 35 36 37 38 39 40 41 42 43 44 45 46 47 48 49 50 51 52 53 54 55

REF	Bauteile	Strompfad
B1	Temperatursensor ntc	7,9
B2	Sensor Salzmenge	6,8
B3	Sensor Klarspülmangel Optisch	46-48
B5	Aquasensor 1	5
E1	Heizung	38
F1	Türschalter	15,16
F4	Sicherheitsthermostat	38
F5	Sicherheitsdruckschalter	38,39
F6	Schwimmerschalter	24,25
K1	Regenerierventil	21
K2	Füllventil	24
K3	Auslassventil	25
K4	Rohwasserventil	20
K11	Leistungsteil	10,12-15,17-21,23-27,29,30,32-35,37,38,40-45
K12	Bedienteil	40-50,52,53
K14	Anzeigemodul	24,31

REF	Bauteile	Strompfad
M2	Umwälzpumpe	33,34
M3	Laugenpumpe	27
M5	Wasserweiche	17,18
P1	Niveau Schalter	4,6
P2	Betriebsanzeige	41
Q1	Hauptschalter	45,47
Q3	Zugabenaktuator	13
R5	Rauschsperr	49,54

① je nach Ausstattung vorhanden

The reproduction, transmission or use of this document or its contents is not permitted without express written authority. Offenders will be liable for damages. All rights including rights created by patent grant or registration of a utility model or design are reserved. Copyright reserved.

Designation Circuit Diagram AV638 X - Stg	LCS Document No. DE 5600 0000133261 Material No. 9000145324	Rev A	Sheet-No. 1 of 1
---	--	----------	------------------------

To Request

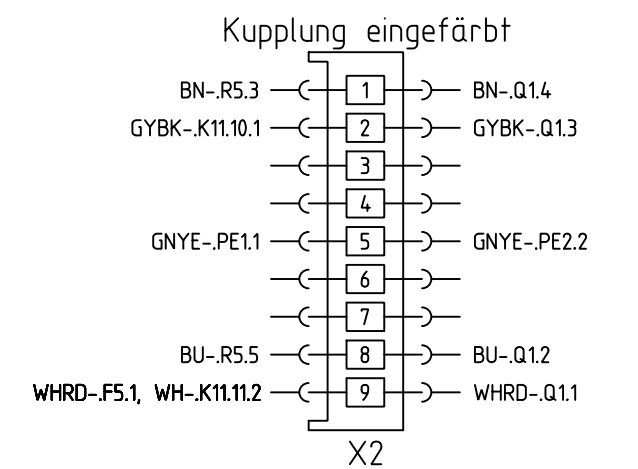
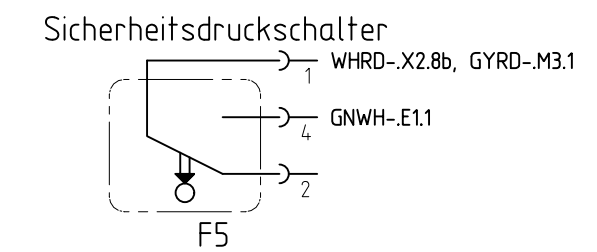
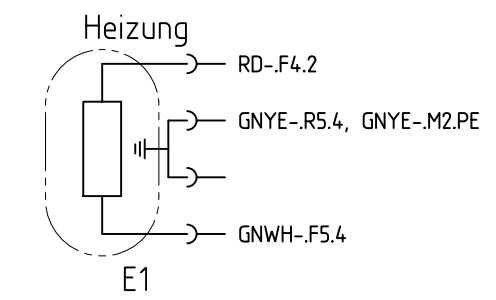
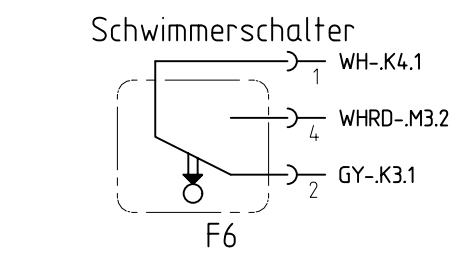
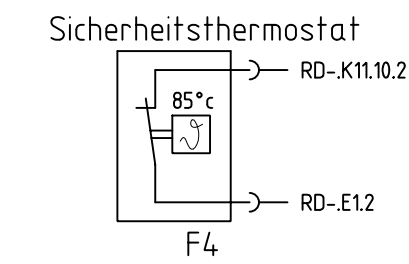
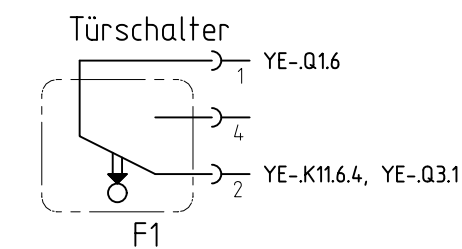
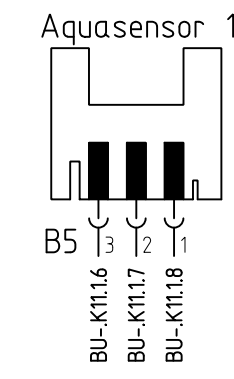
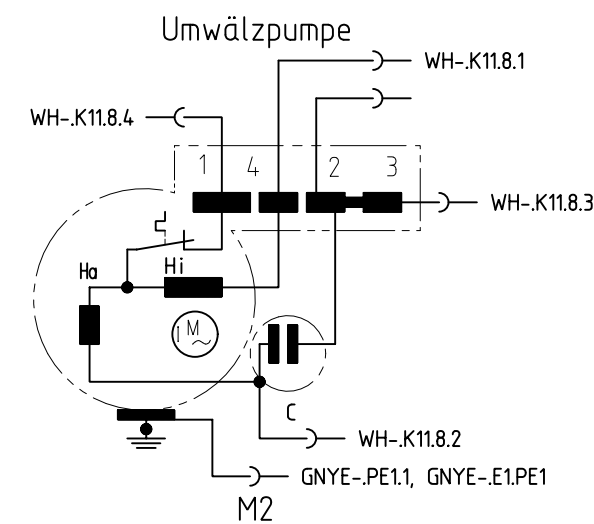
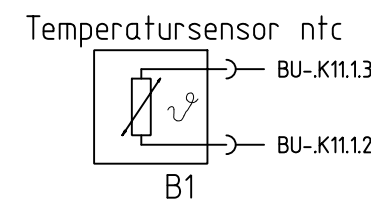
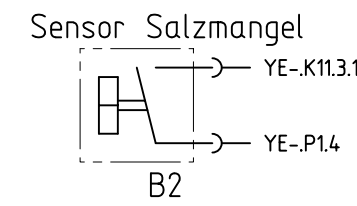
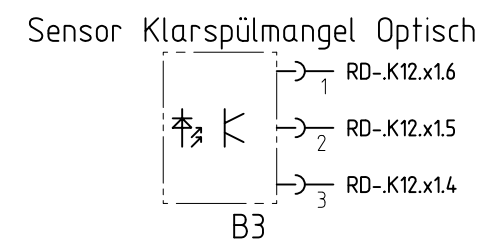
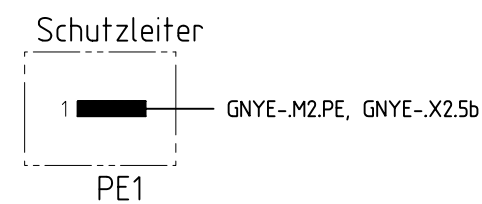
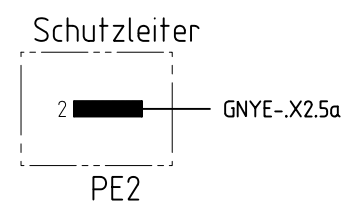
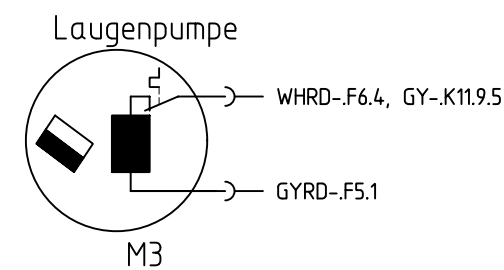
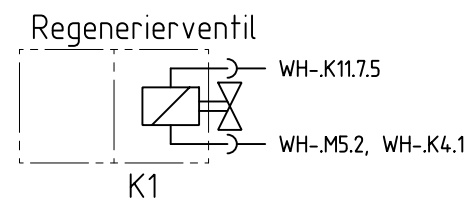
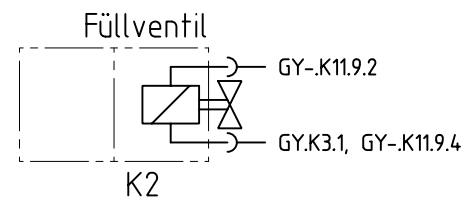
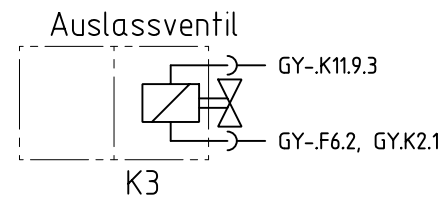
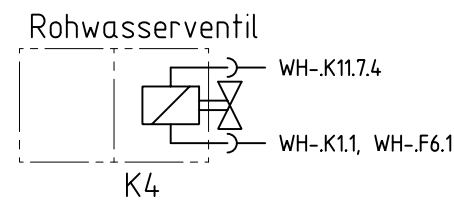
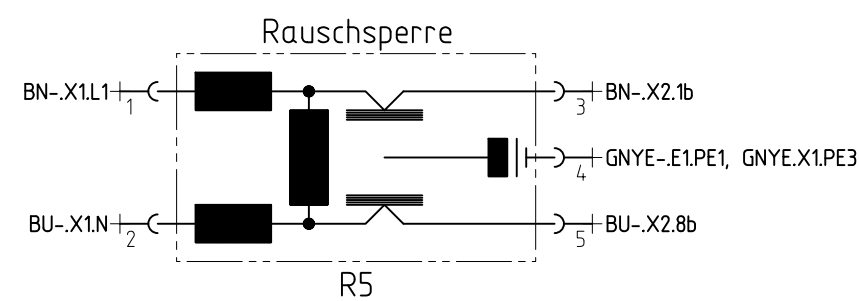
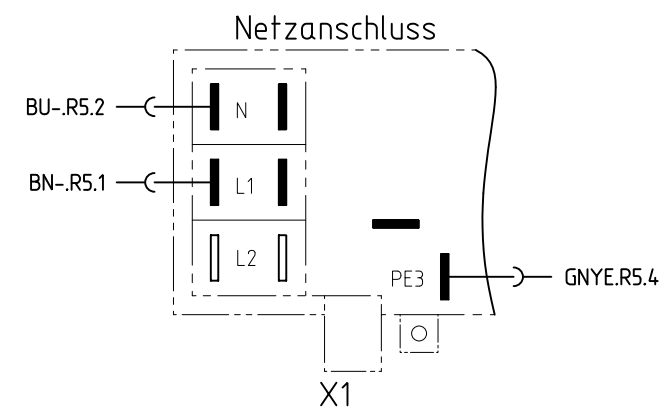
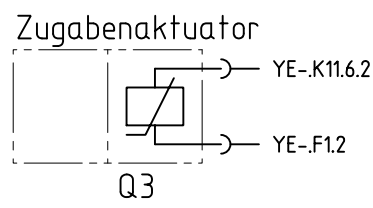
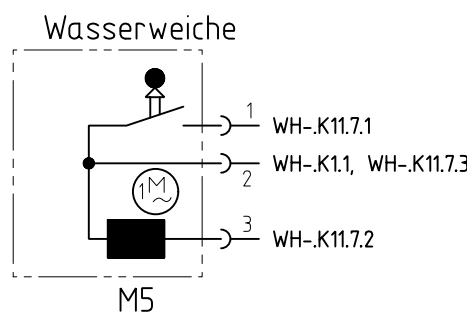
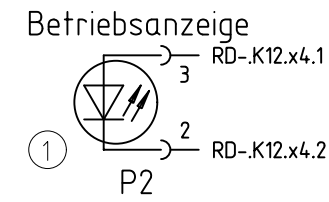
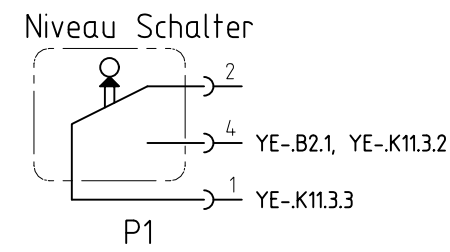
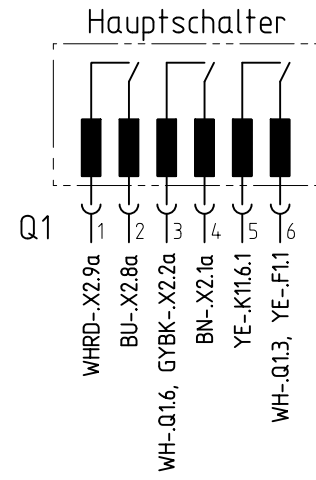
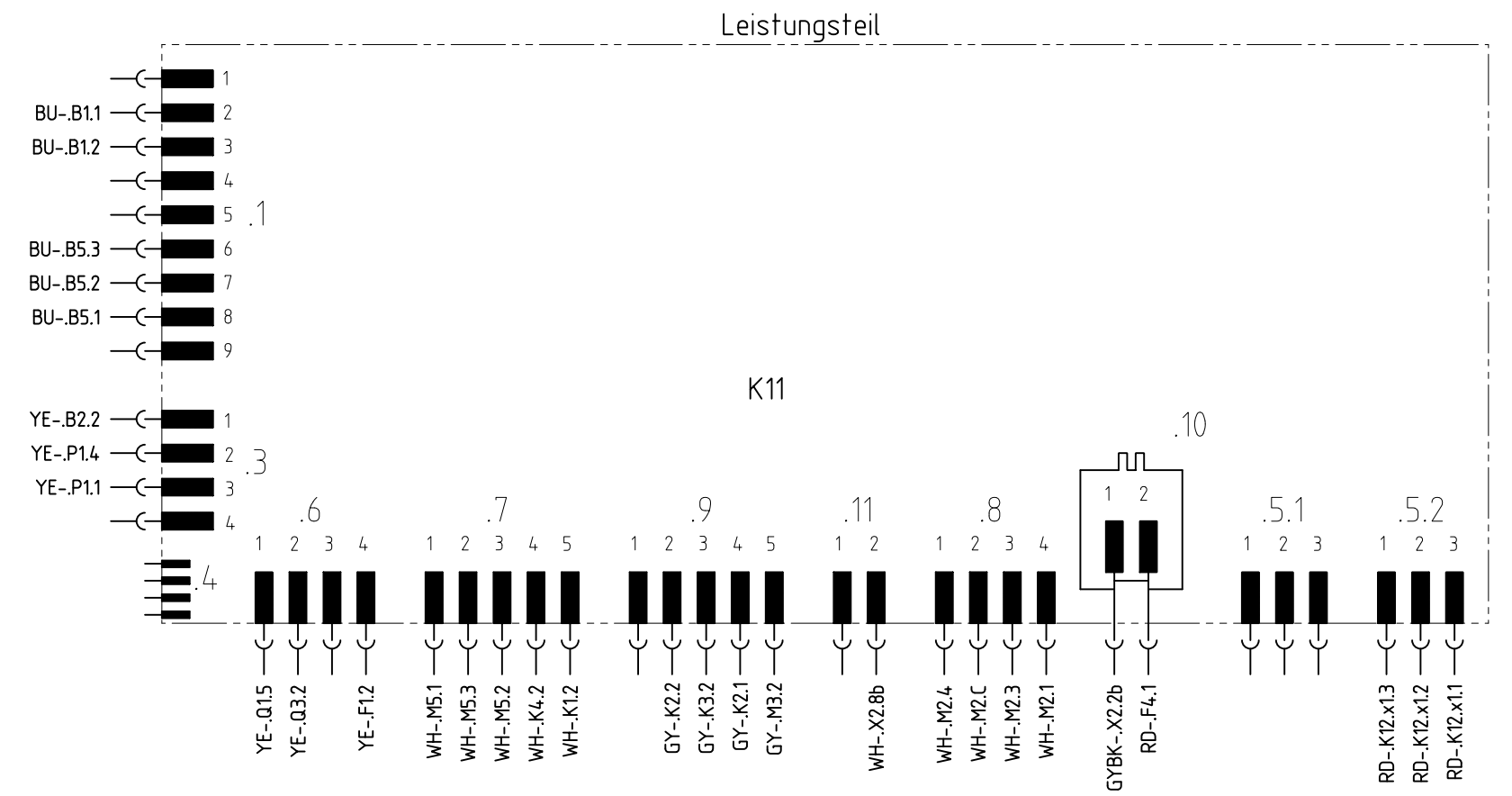
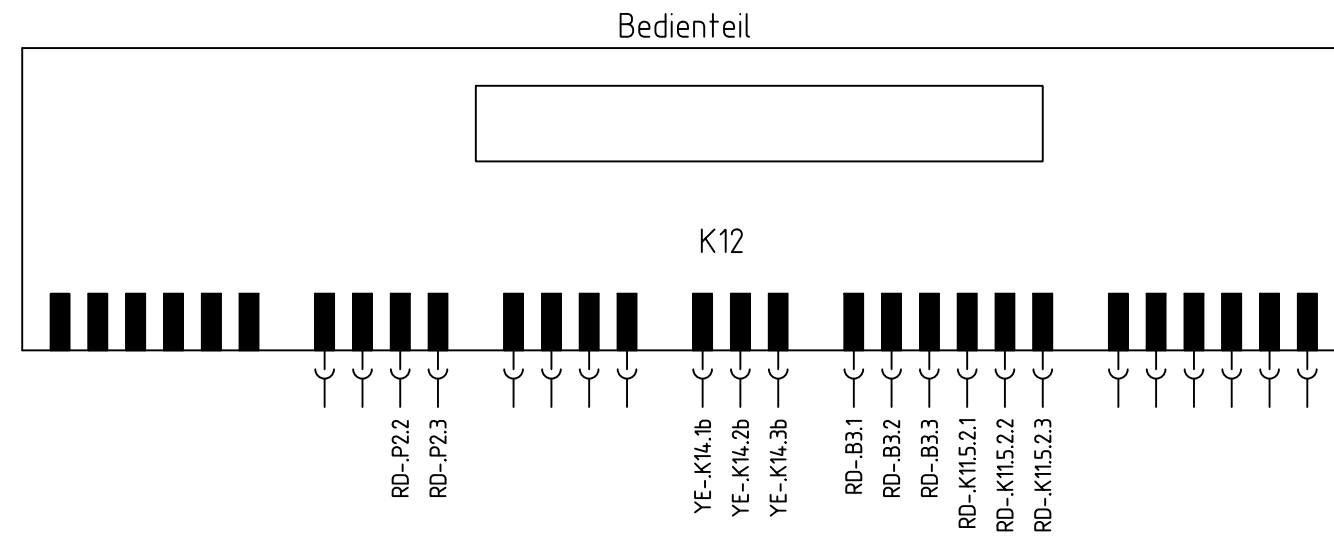
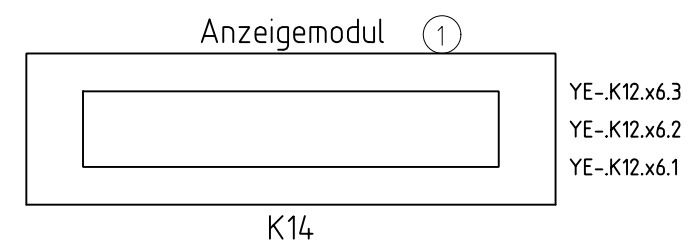

① je nach Ausstattung vorhanden

DE KD-Prüfprogramm

1. Aufruf:

- Bei geöffneter Tür zwei beliebige Tasten gedrückt halten
- Hauptschalter so lange betätigen bis im Display die Variantenkodierung angezeigt wird.

2. Sonderprogramm auswählen:

- Nach dem Lösen der beiden Tasten leuchtet LED L3 und die LED L4 blinkt.
- Im Display wird P0 angezeigt.
- Taste S4 drücken um das Sonderprogramm Fehlerspeicherauslesen zu aktivieren

3. Fehlerspeicher auslesen (P0)

- Taste S4 abwechselnd drücken. Bei gedrückter Taste wird der Spülgang angezeigt (00 – 07), bei gelöster Taste wird der dazu gehörige Fehler (siehe Tabelle) angezeigt.
- Treten in einem Spülgang mehrere Fehler auf, so wird nur der Fehler mit der höchsten Wertigkeit angezeigt.

4. KD-Prüfprogramm (P1)

- Türe schließen, Kundendienstprogramm wird gestartet.
- Taste S3 drücken um Programmpositionen zu überspringen (Ausnahme: Beim Füllschritt weiterschalten nur durch den Füllschalter F1)
- Jede Zustandsänderung der Prozessoreingänge wird durch kurzes Aufleuchten aller LED's bestätigt.
- Ein aufgetretener Fehler wird sofort über das Display angezeigt (Heizfehler nach 10 Minuten). Bei mehreren Fehlern wird nur der hochwertigste angezeigt. Nach jeder Reparatur ist ein KD Prüfprogramm durchzuführen um ggf. weitere Fehler zu erkennen.

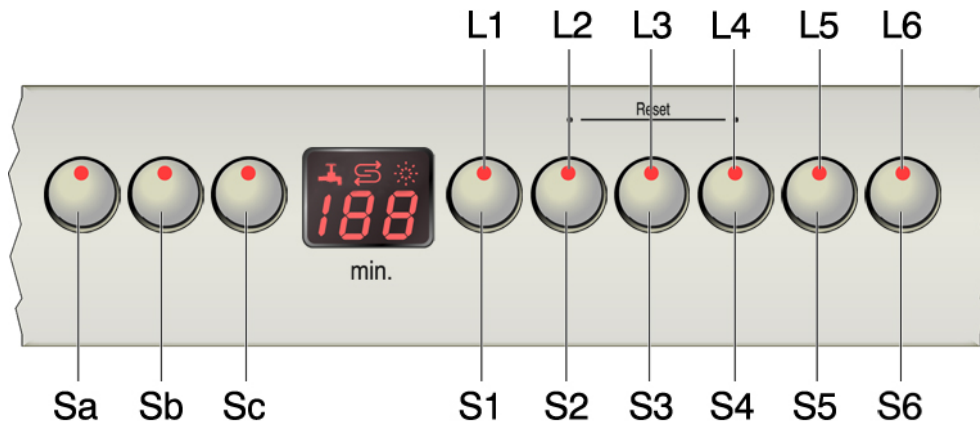

EN Customer service test programme

1. Selecting the model coding:

- When the door is open, hold down any two buttons
- Press main switch until the model coding is indicated on the display.

2. Select special programme:

- When the two buttons are released, LED L3 lights up and LED L4 flashes
- P0 is displayed.
- Press S4 button to activate special programme "read out fault memory"

3. Read out fault memory (P0)

- Press S4 button alternating. With pressed key the rinsing process is indicated (00 - 07), with solved key the error due to it (see table) is indicated.
- If several faults occur in a wash cycle, only the fault with the highest value is displayed.

4. Customer service test programme (P1)

- The customer service programme is started by closing the door.
- Switch to the next programme position with the S3 button (Exception: Move to the next filling step by pressing filling switch F1 only).
- Each status change of the processor inputs is acknowledged by all LEDs lighting up briefly.
- A fault which has occurred is indicated immediately via the display (heating fault after 10 minutes). If several faults occur, only the fault with the highest value is displayed. Following each repair a customer service test programme must be run to detect any other faults.

Document No. 56000000137026 ASP INT A	Rev. A	Sheet-No. 1 of 2
Material No. 9000 182 417	GV638, X	

Fehlercode / Fault code

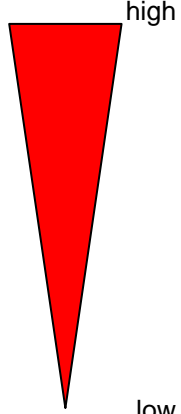
Fehlercode / Fault code	Fehlerart / Fault type	Wertigkeit / Value
E1	Heizfehler Heating fault	
E2	NTC Fehler NTC fault	
E3	Füllfehler Filling fault	
E4	Wasserweiche nicht positionierbar Water points cannot be positioned	
E5	Sicherheitsniveau erreicht Safety level reached	
E6	Aquasensor Aqua sensor	
E7	---	

	Kurzzeichen	Symbol
P	Pumpen	Pump
VF	Vorfüllen	Prefill
F	Füllen	Fill
U	Umwälzen	Circulate
H	Heizen	Heating
ZR	Zugabe Reiniger	Dispense detergent
ZK	Zugabe Klarspüler	Dispense rinse aid
R	Regenerierventil	Regeneration valve
FWW	Füllen Weichwasser	Fill soft water
AS_KAL	Aquasensor kalibrieren	Calibrate Aqua sensor
AWT	Auslaufventil Wärmetauscher	Heat exchanger outlet valve
WP	Wechsellpumpen	Alternating pump
SP	Stotterpumpen	Intermittent pump
WS	Wechselspülen	Intermittent wash
OK	Oberkorb	Top basket

Ablauf des KD-Prüfprogramm / Sequence of the customer service test programme

	Funktion / Function	Temperatur / Temperature	Zeit (s) / Time (s)	Sensor / Sensor	Füllmenge / Capacity	Spülart / Rinsing kind
0	P		15			
1	VF			F1		
2	PA		5			
3-5	F				3,9 l	
6	U + H + ZR	max. 72°	120			WS mit OK gedrosselt / WS with OK reduced
7	U + H	60°C				WS
8	U + H + R	max. 72°	120			WS
9	U + ZK		120			WS
10	AS_KAL		30			
11-16	WP		30			
17	P		45			
18	FWW + AWT		60			
19-24	SP		30			
25	P + AWT		30			

Document No. 56000000137026 ASP INT A	Rev. A	Sheet-No. 2 of 2
Material No. 9000 182 417	GV638, X	