

Nach Layoutänderung

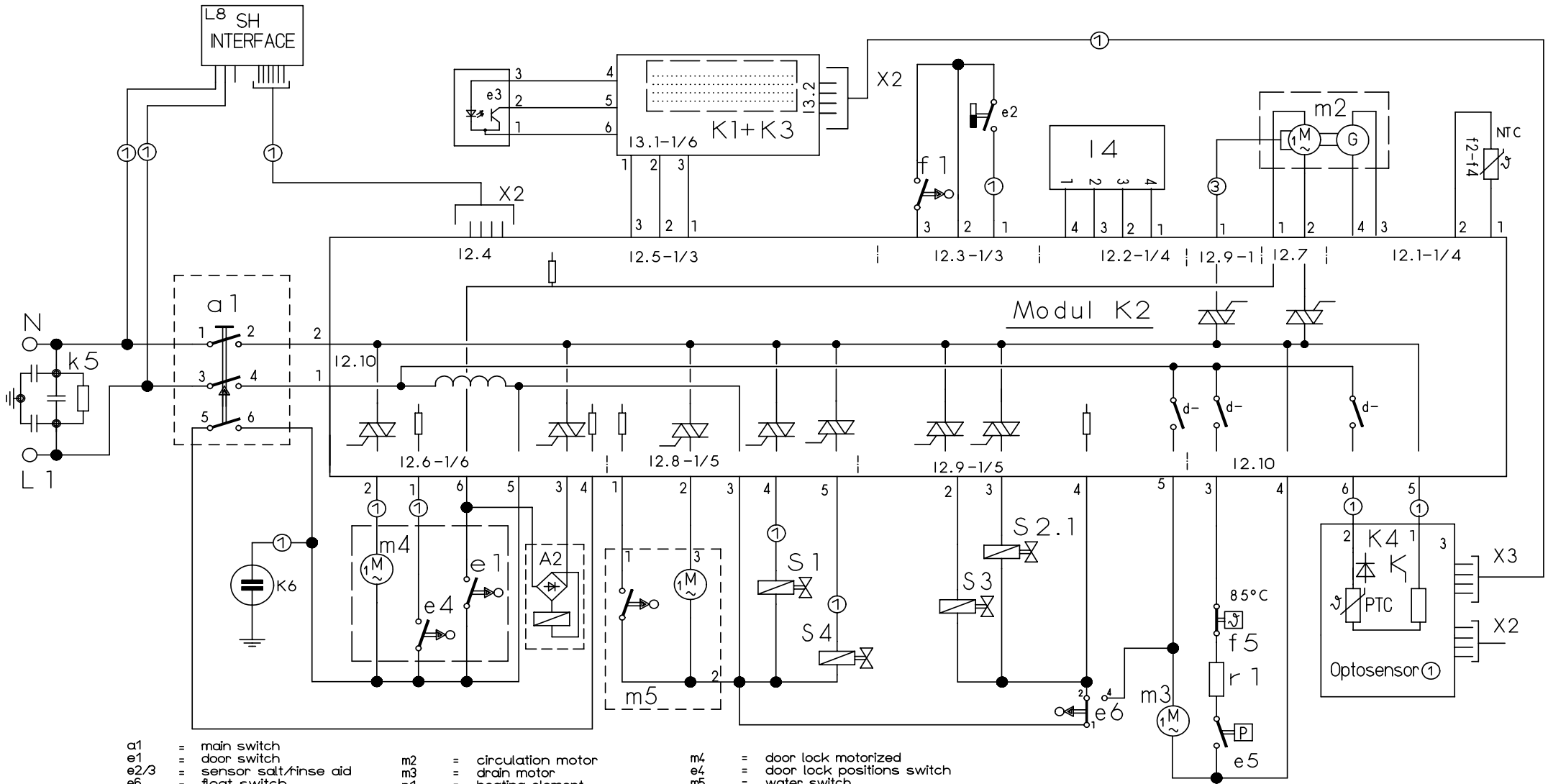

- a1 = main switch
- e1 = door switch
- e2/3 = sensor salt/rinse aid
- e6 = float switch
- f1 = level switch
- NTC = temperature sensor
- f5 = thermostat
- k5 = interference suppression
- K1 = display modul
- K2 = control modul
- K3 = timer modul
- K4 = optosensor
- m2 = circulation motor
- m3 = drain motor
- r1 = heating element
- r2 = dryer heater
- e5 = pressure switch
- s1 = regenerating valve
- s2 = filling valve
- s3 = transfer valve
- A2 = dispenser
- x2 = service-connector
- m4 = door lock motorized
- e4 = door lock positions switch
- m5 = water switch
- L4 = aqua sensor
- k6 = interference suppression
- s4 = raw water valve
- L8 = SH-Interface

- ① exit according to equipment
- ③ starting Relais



Mat. Nr. 5600049493	
Ausg.: 09.02	S0-60/ 0671

time delay + display modul

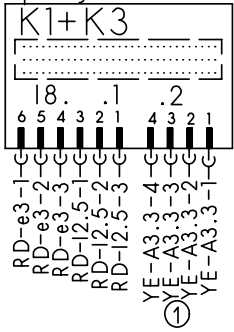

main switch

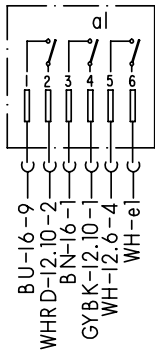

control modul

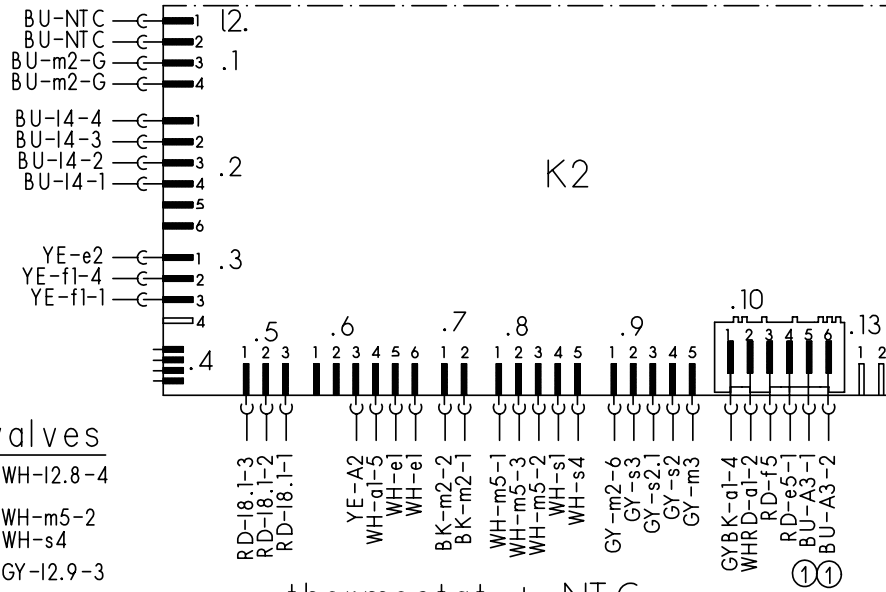

sensor

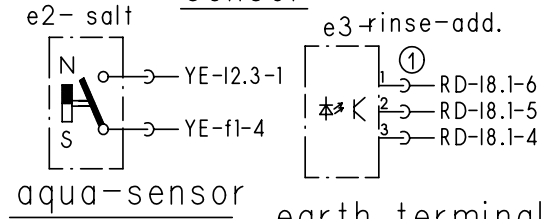

door switch

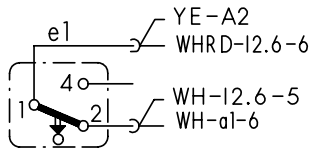

solenoid valves

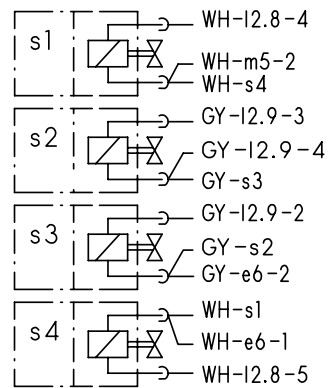

thermostat + NTC

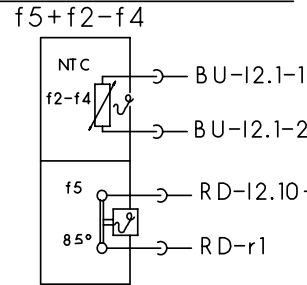

aktuator addition device

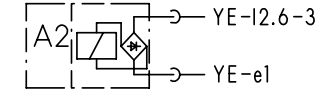

earth terminal

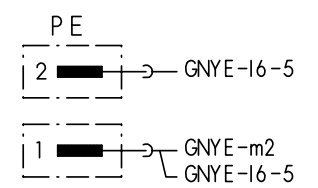

Optosensor

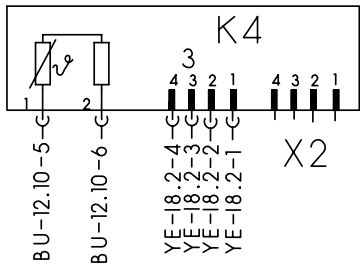

water points

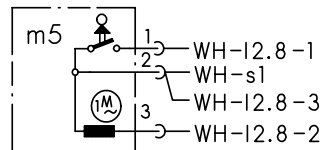

heating

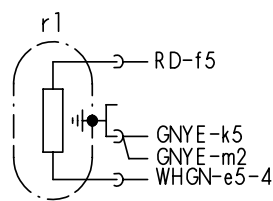

float switch

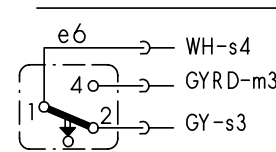

drain pump

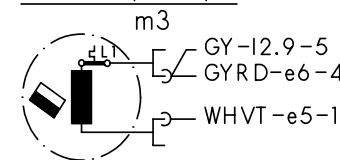

safety switch

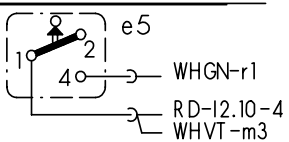

terminal I1 with interference suppression

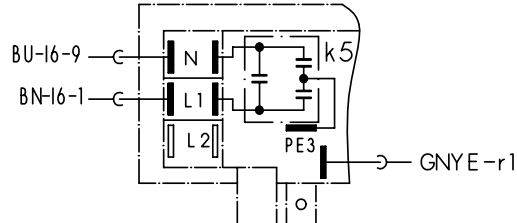

starting Relais

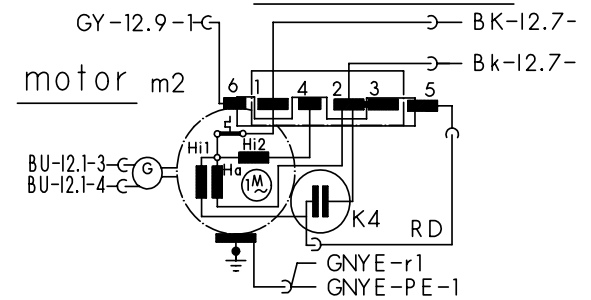

level switch

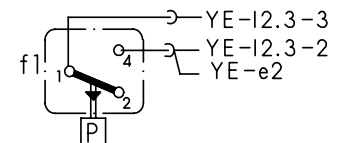

Mat.Nr.:	5600049492
Ausg.:	09.02 SO-60/ 0672



(1) exist according to equipment

## Customer-service test programme

### Selecting the special programmes:

Open door; press and hold down the two buttons on the left next to the display; switch on the main switch. The selection of special programmes is displayed. Select special programme S3 with the upper buttons. The programme is started with the lower right button (Start).

The last 8 rinse cycles can be selected from the error memory by pressing the upper buttons (e.g.: in Cycle 1 = penultimate rinse cycle). The selected programme (S3) and the errors which occurred in this rinse cycle are displayed encoded on the lower line (e.g.: errors B and K have occurred in the penultimate rinse cycle).

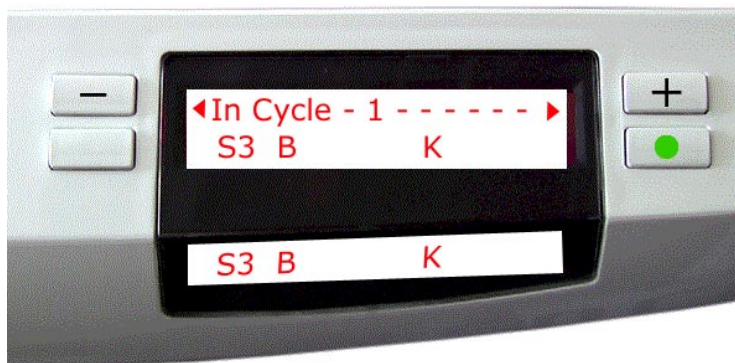

The last 8 rinse cycles can be selected with the upper buttons ◀ / ▶.

### Error codes

- A = Aqua sensor calibration fault, infrared measuring distance
- B = Aqua sensor calibration fault, green measuring distance
- C = No tachogenerator pulses
- D = Triac short-circuit, circulation pump output
- E = Water points, no switching pulses

- F = Filling fault
- G = Triac short-circuit, water points output
- H = Heater fault
- I = Motor lock, no switching pulses
- J = Triac short-circuit, motor lock output
- K = NTC fault, interruption or short-circuit
- L = - - -
- M = Overtravel continuously on
- N = Mains synchronisation not possible
- O = Safety level detected
- P = Safety level (O) detected 8 times

Close door, then start the customer service programme (see programme sequence table).

When the programme has started, each programme step and each status change of the switching contacts are acknowledged with an acoustic signal.

The selected programme (S3), the errors and the programme position are displayed on the lower line. Positions can be skipped with the upper left button (Step).

The filling positions are an exception!



The error memory can be deleted with special programme S6.



5600.037.805	Ausg.: 11.02
	S0-60/0532

# Customer service test programme (programme sequence)

Pos.	Function	Time [s]	Sensor	OK/UK/WS	r.p.m. UK	r.p.m. OK	r.p.m. WK	Time [s] UK	Time [s] OK	Amount
0	P	30								
1	Open optical sensor valve	2								
2	FWW + AS_KAL_IR + Opto_Mess_1									1.0 l
3	Pa + AS_KAL_IR	2								
4	FRW + AS_KAL_IR									1.0 l
5	Pa + AS_KAL_IR	2								
6	VF + AS_KAL_IR		f1							
7	Pa	2								
8	AS_KAL_GN	60								
9	AWT	60								
10	R	10								
11	ZR	90								
12 – 17	WWP			OK / UK						
18	Auxiliary winding reversal relay (SIKASYM)+U	10 + 20		UK	2800					
19	WWP			OK			2800			
20	U	20		OK		2000				
21	U + H	250	Max. 65 °C	WS	2500	1500	2000	15	15	
22	P	5								
23	U	5			2100					
24	P	5								
25	U	5			2100					
26	P	5								
27	U	5			2100					
28	ZK	90								
29	FWW + AWT									1.0 l
30	AWT	10								
31	P	5								
32	U	5			2100					
33	P	5								
34	U	5			2100					
35	P	5								
36	U	5			2100					
37	Opto_Mess_2	2								
38	Open optical sensor valve	2								
39	P	30								
00	End of programme									

**Note:** In Pos. 21 the circulation pump is actuated only at 1500 r.p.m. for top basket rinsing. At this speed the upper spray arm cannot rotate or rotates only very slowly. The position switch is actuated 4 times to position the water points whenever OK switches to UK (or UK to OK). An acoustic signal is emitted whenever the position switch is actuated.

AWT=Heat exchanger outlet valve

P=Pump

WS=Alternate rinsing

ZR=Dispense detergent

MSP=Position motor lock

FRW=Fill with untreated water

Pa=Pause

WWP=Position water points

ZK=Dispense rinse aid

AS\_KAL\_IR=Calibrate IR Aqua sensor

FWW=Fill with soft water

R=Regeneration valve

WK=Switch between UK / OK

OK=Top basket

AS\_KAL\_GN=Calibrate GN Aqua sensor

H=Heater

U=Recirculate

VF=Prefill heat exchanger f1

UK=Bottom basket

Opto\_Mess = Optical sensor measurement



5600 049 386	Ausg.: 08.02
GV635, Opto ab FD8206	S0-60/0702