

aqua-sensor

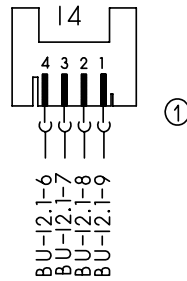

control modul

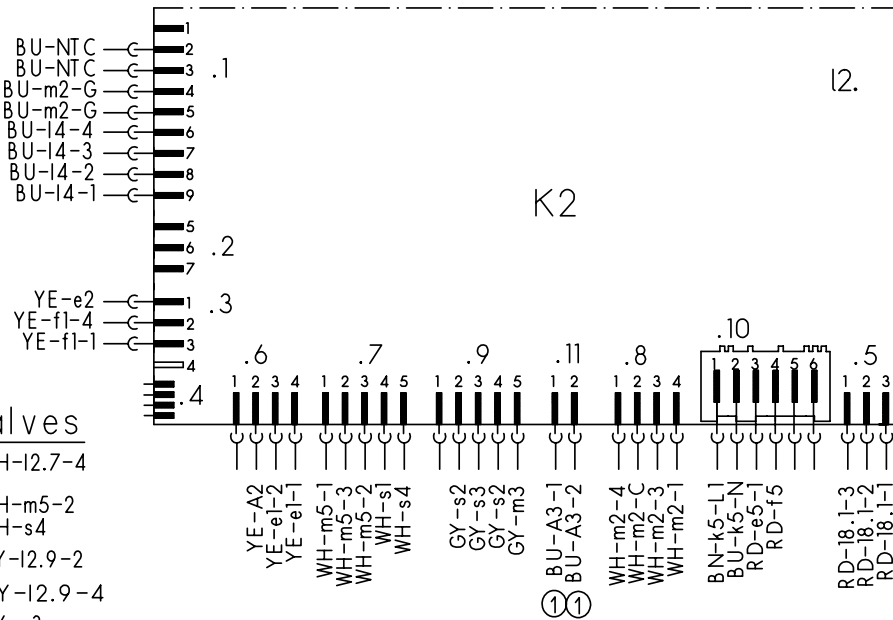

sensor ①

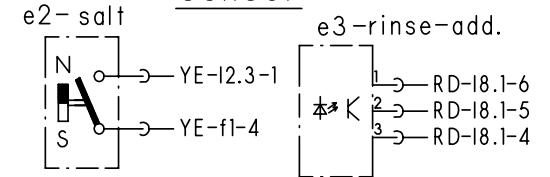

① display modul

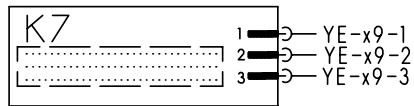

solenoid valves

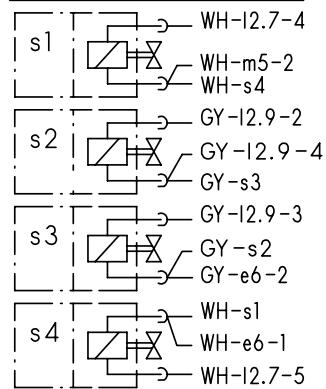

① Optosensor

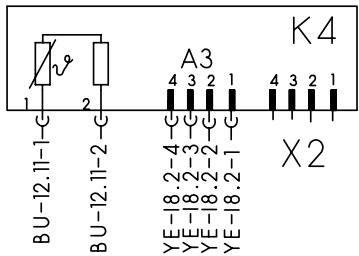

spot-light

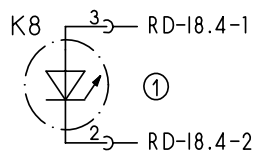

thermostat + NTC

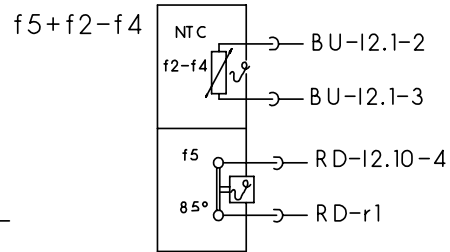

safety switch

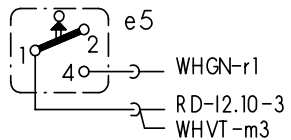

water points

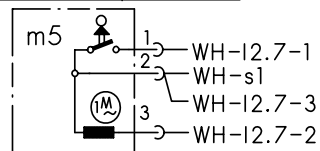

terminal I1 with

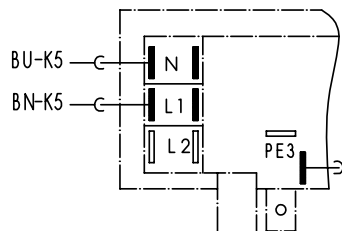

interference suppression

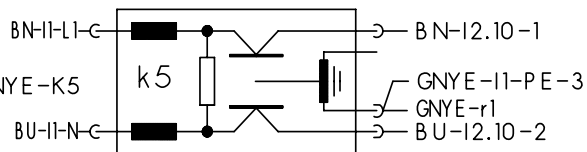

heating

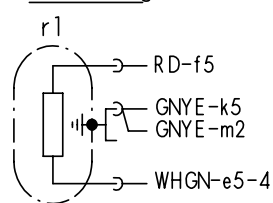

door switch

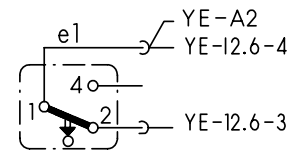

drain pump

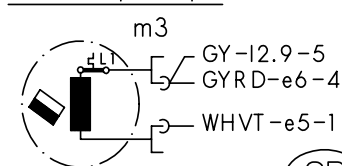

earth terminal

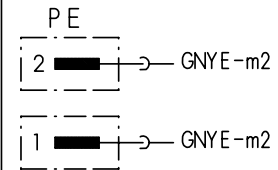

aktuator

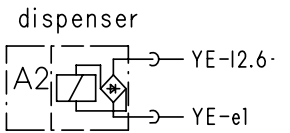

① clutch

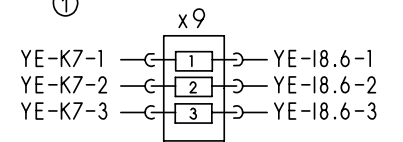

motor

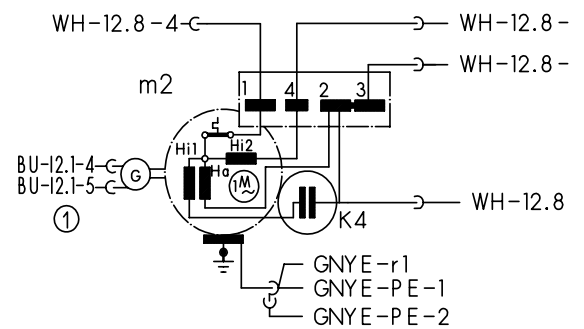

level switch

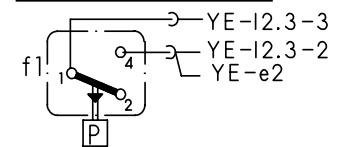

Mat.Nr.:	5600057150
Ausg.:	10.03
	58300000019416

① exist according to equipment



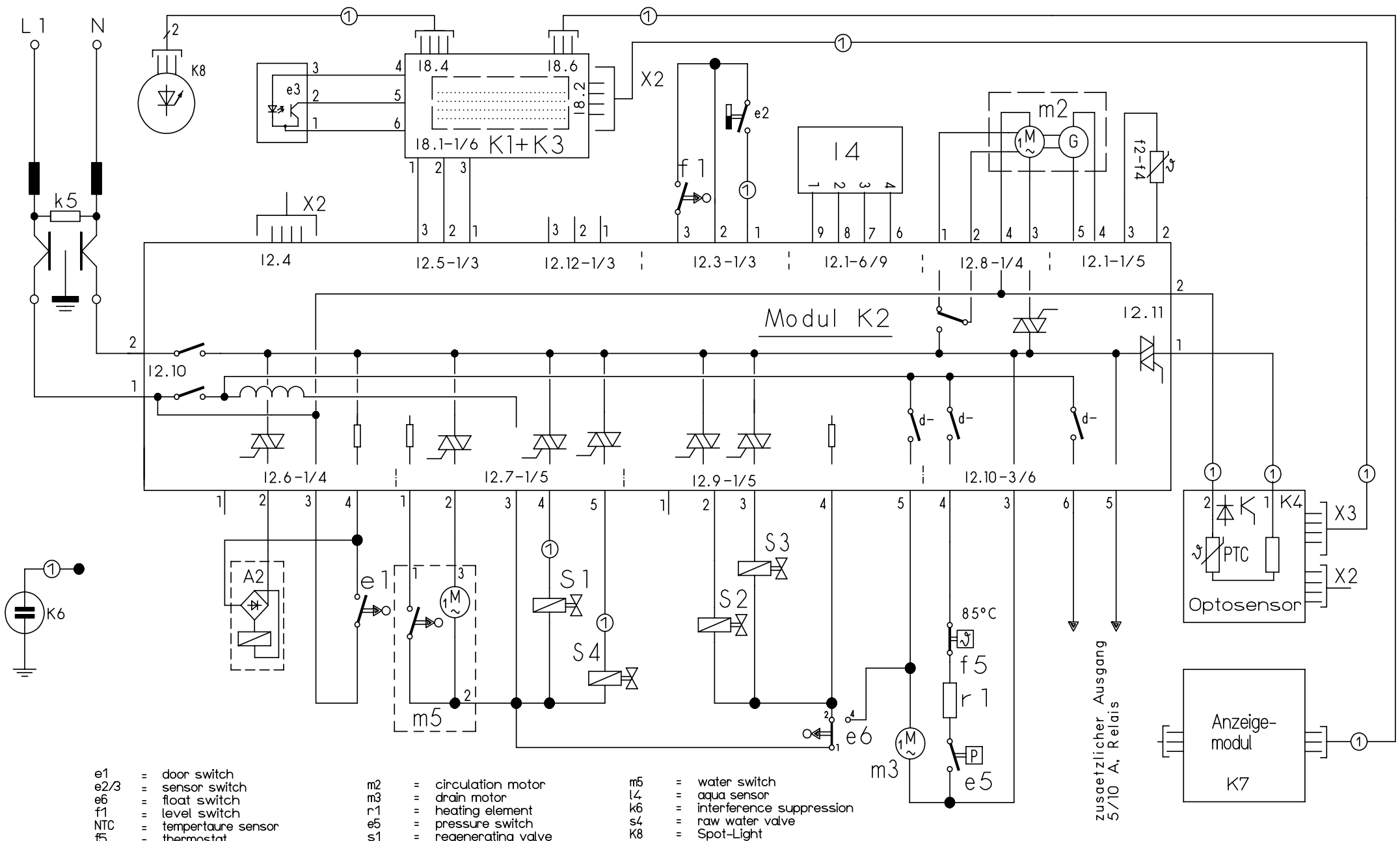

- | | | | | | |
|------|----------------------------|----|----------------------|----|----------------------------|
| e1 | = door switch | m2 | = circulation motor | m5 | = water switch |
| e2/3 | = sensor switch | m3 | = drain motor | l4 | = aqua sensor |
| e6 | = float switch | r1 | = heating element | k6 | = interference suppression |
| f1 | = level switch | e5 | = pressure switch | s4 | = raw water valve |
| NTC | = tempertaure sensor | s1 | = regenerating valve | K8 | = Spot-Light |
| f5 | = thermostat | s2 | = filling valve | | |
| k5 | = interference suppression | s3 | = transfer valve | | |
| K1 | = display modul | A2 | = actuator | | |
| K2 | = control modul | x2 | = service-connector | | |
| K3 | = timer modul | | | | |
| K4 | = electronic optosensor | | | | |
| K7 | = display modul | | | | |

zusätzlicher Ausgang
5/10 A, Relais

Mat. Nr. 5600057151	
Ausg.: 10.03	S0-60/0821

① exit according to equipment



Customer service test programme

1. Selecting the model coding:

Open the door; switch off the appliance; simultaneously press and hold down the two right sensor buttons “E and F”; also press sensor button “A” for at least 3 sec.

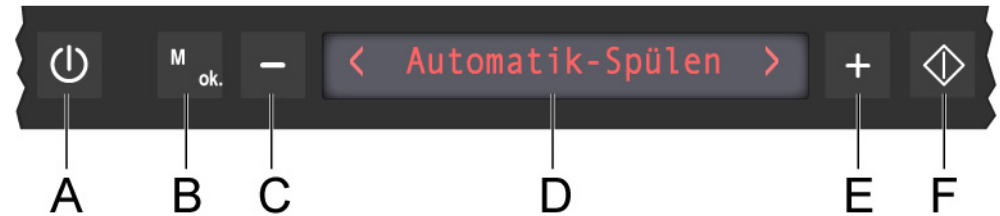

2. Select special programme:

Select the Customer – Service (S3) special programme by pressing the sensor buttons “C und E” and acknowledge with button “F”.

3. Display the fault memory:

If the Customer Service programme is started via sensor button “F”, the fault memory of the last wash cycle is indicated via the display. The fault memory of the last 8 wash cycles can be read out via the +/- buttons. S3 for Customer Service programme, the fault code and the wash cycle are displayed.



4. Start the customer service programme:

When the fault memory has been displayed, the customer service programme is started by closing the door.

Programme steps can be skipped with the + button. Exception are the filling steps. S3 for Customer Service programme, the fault code and the programme step are displayed.

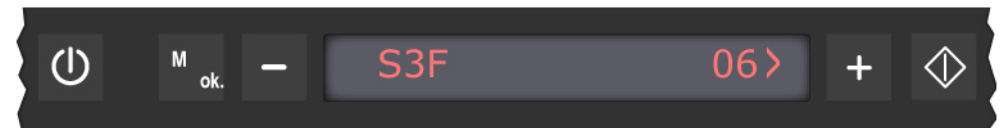

While the customer service programme is selected, each status change of the analogue signal inputs is acknowledged by the electronics module with an acoustic signal.

5600 059 583	Ausg.: 03.04
GV637 T	S0-60/0887 4/1

5. Fault code:

Fault code	Fault type
A	Aqua sensor calibration fault infrared measuring distance
B	Aqua sensor calibration fault green measuring distance
C	No tachimpulses
D	Triac short-circuit, circulation pump
E	Water points, no switching impulses
F	Filling fault
G	Triac short-circuit, water points
H	Heating fault
I	- - -
J	- - -
K	NTC fault, interruption / short-circuit
L	Optical sensor, fault or no communication
M	Mains isolating relay stuck
N	Mains synchronisation not possible
O	Safety level detected
P	Safety level (O) detected 8 times

6. Abbreviations for programme sequence:

AWT= Heat exchanger outlet valve

P= Pump

WS = Alternate washing

ZR= Dispense detergent

FRW = Fill raw water

Pa = Pause

WWP = Position water points

ZK= Dispense rinse aid

FWW= Fill soft water

R= Regeneration valve

WK = Switch between UK / OK

OK = Top basket

H= Heat

U= Circulate

VF = Prefill heat exchanger F1

UK = Bottom basket

Opto_Mess = Optical sensor measurement

AS_KAL_IR= Calibrate IR Aqua sensor

AS_KAL_GN= Calibrate GN Aqua sensor

5600 059 583	Ausg.: 03.04
GV637 T	S0-60/0887 4/2

7. Sequence of the customer service test programme:

	Function	Time (s)	Temperature	Quantity	Washing technology	Sensor	r.p.m. UK	r.p.m. OK	r.p.m. WK	Time [s] OK/UK
0	P	30								
1	Optical sensor PTC on	2								
2	FWW + AS_KAL_IR + Opto_Mess_1			1.0 l						
3	Pa + AS_KAL_IR	2								
4	FRW + AS_KAL_IR			1.0 l						
5	Pa + AS_KAL_IR	2								
6	VF + AS_KAL_IR					F1				
7	Pa	2								
8	AS_KAL_GN	60								
9	AWT	60								
10	R	10								
11	ZR	90								
12-17	WWP				OK / UK					
18	Reversal relay auxiliary winding (SICASYM) + U	10 + 20			UK		Maximum			
19	WWP				OK					
20	U	20			OK			2200		
21	U + H	250	Max. 67°		WS		2500	1500	2000	15
22	P	5								
23	U	5								
24	P	5								
25	U	5								
26	P	5								
27	U	5								
28	ZK	90								
29	FWW + AWT			1.0 l						
30	AWT	10								
31	P	5								
32	U	5								
33	P	5								
34	U	5								
35	P	5								
36	U	5								
37	Opto_Mess_2	2								
38	Optical sensor PTC on	2								
39	P	30								
00	End of programme									

5600 059 583	Ausg.: 03.04
GV637 T	S0-60/0887 4/3

Note: In Pos. 21 the circulation pump is activated for top basket washing at 1500 r.p.m. only. At this speed the upper spray arm cannot rotate or can rotate only very slowly. When the water points are positioned, the position switch is actuated 4 times whenever there is a change from OK to UK (or UK to OK). Whenever the position switch is actuated, an acoustic signal sounds.

5600 059 583	Ausg.: 03.04
GV637 T	S0-60/0887 4/4