

The reproduction, transmission or use of this document or its contents is not permitted without express written authority. Offenders will be liable for damages. All rights including rights created by patent grant or registration of a utility model or design are reserved. Copyright reserved.

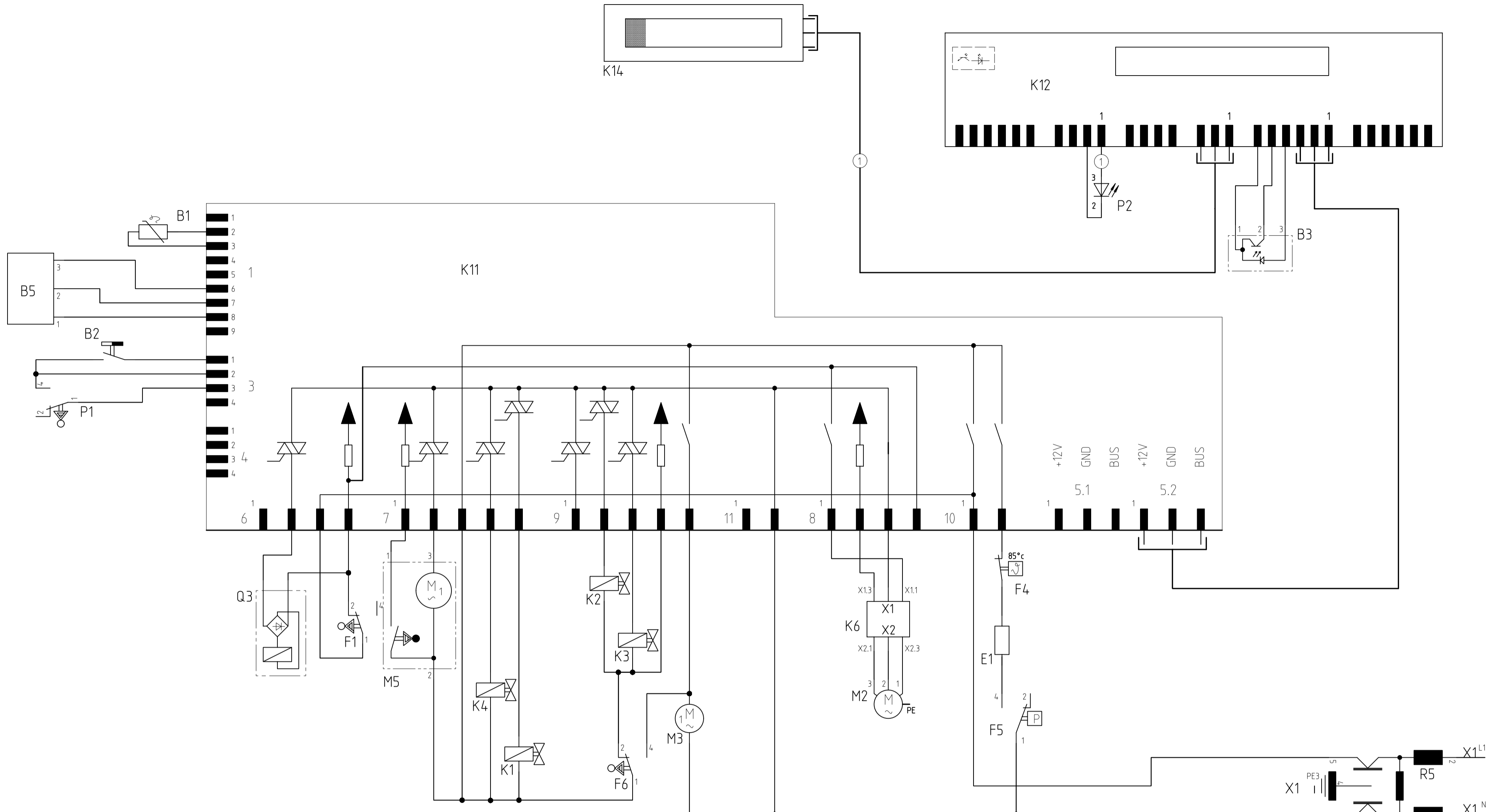

1 2 3 4 5 6 7 8 9 10 11 12 13 14 15 16 17 18 19 20 21 22 23 24 25 26 27 28 29 30 31 32 33 34 35 36 37 38 39 40 41 42 43 44 45 46 47 48 49 50 51 52 53 54 55

REF	Components	Path	REF	Components	Path
B1	Temperature sensor NTC	7-9	K14	Display module	24-31
B2	Low salt sensor	6-8	M2	Circulation pump	33-35
B3	Low rinse aid sensor optical	46-48	M3	Detergent solution pump	27
B5	Aqua sensor 1	5	M5	Water switch	17-18
E1	Heater	38	P1	Level switch	4-6
F1	Door switch	15-16	P2	On light	42
F4	Safety thermostat	38	Q3	Dispenser coil	12-13
F5	Safety pressure switch	38-39	R5	Interference suppressor	49-54
F6	Safety pressure switch	24-26			
K1	Regeneration valve	21			
K2	Filler valve	24			
K3	Drainage valve	25			
K4	Raw water valve	20			
K6	Motor control unit	33-34			
K11	Power unit	10-45			
K12	Operating unit	40-53			

① Fitted depending on features

To Request

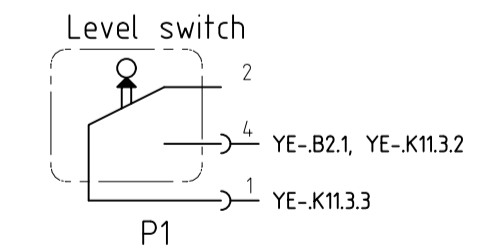
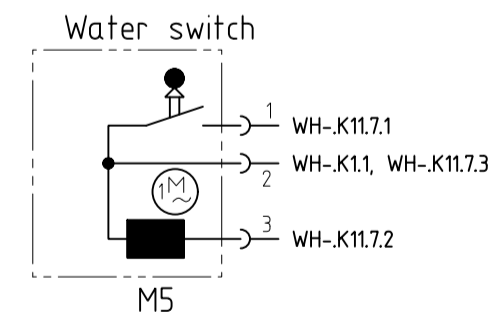
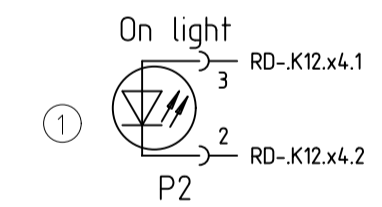
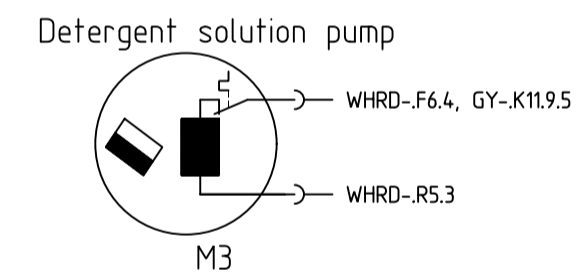
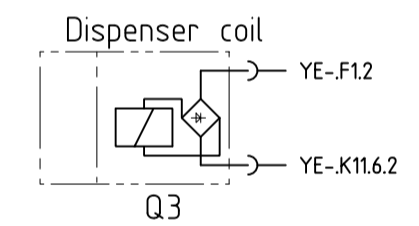
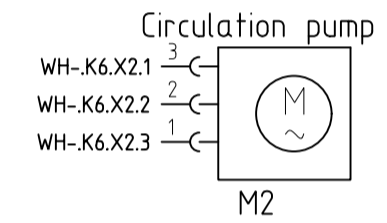
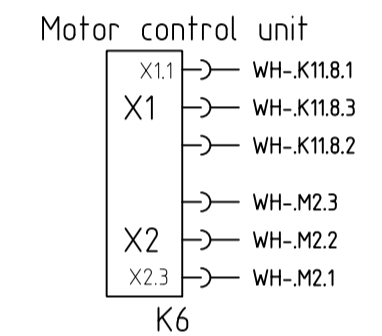
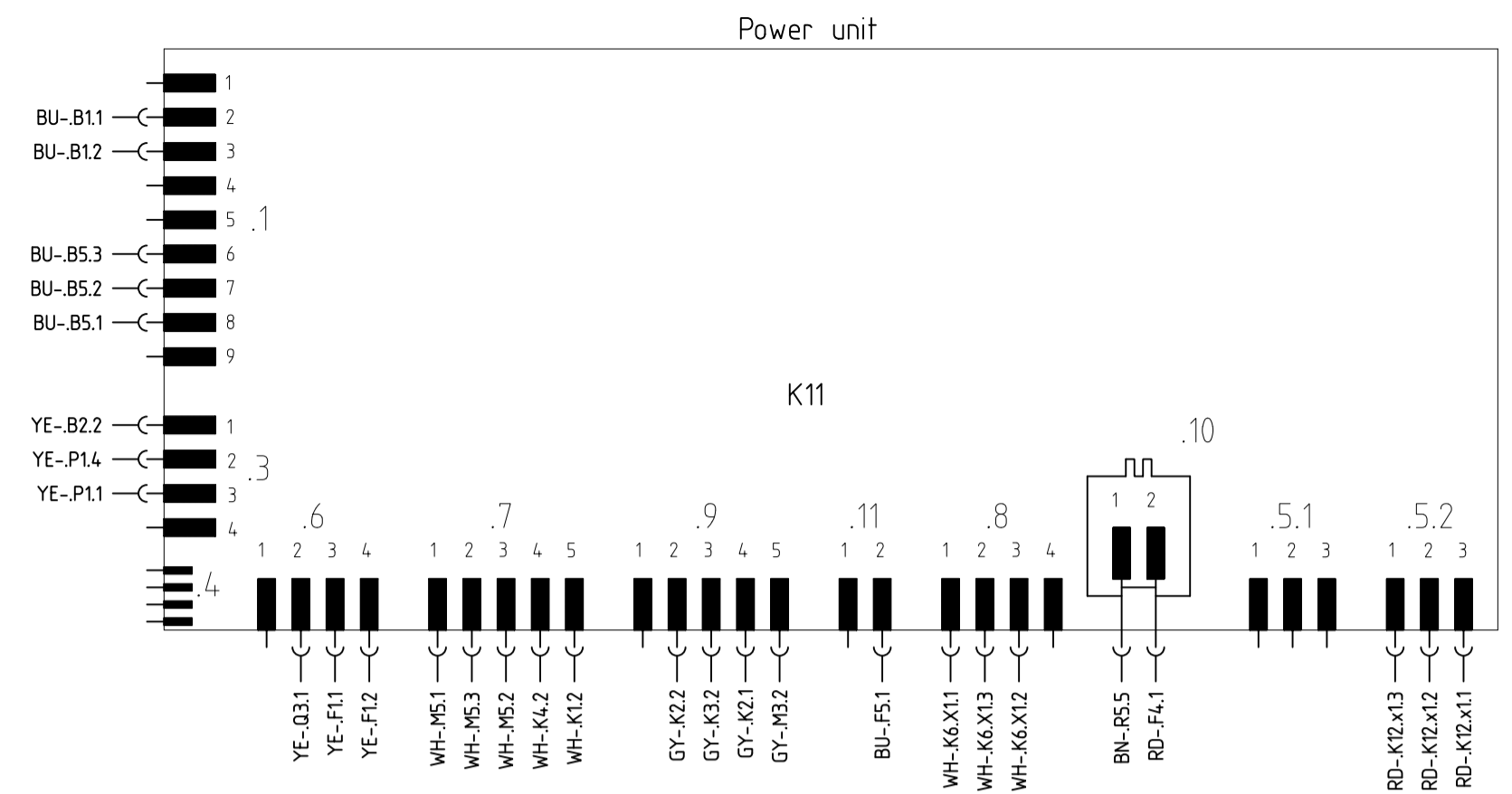
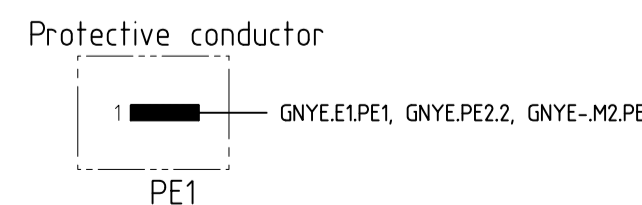
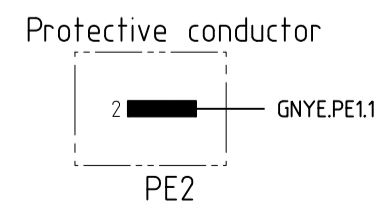
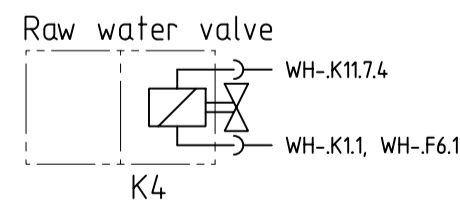
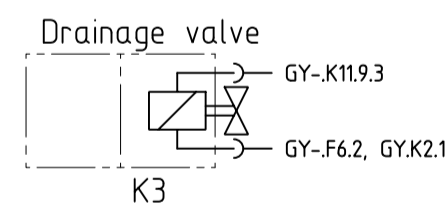
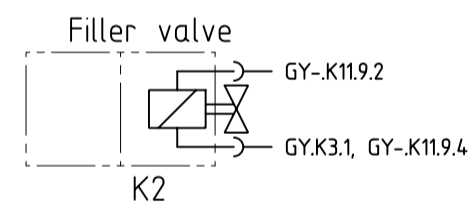
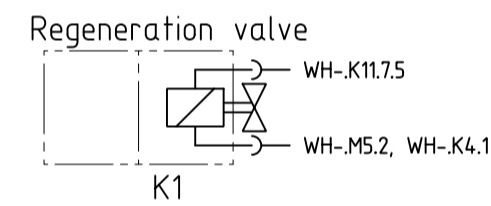
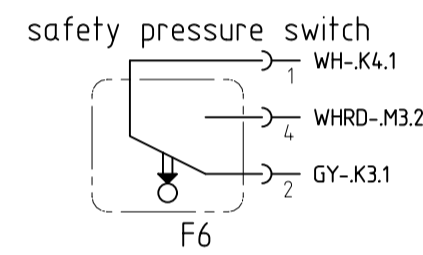
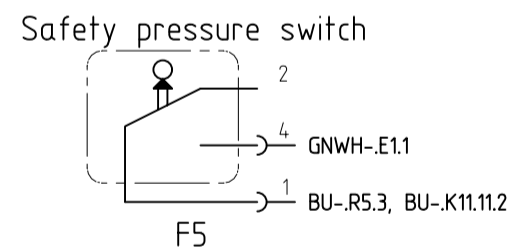
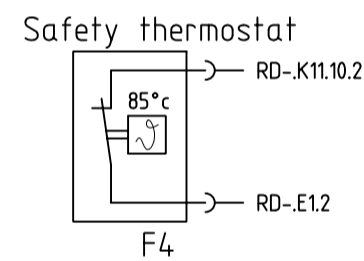
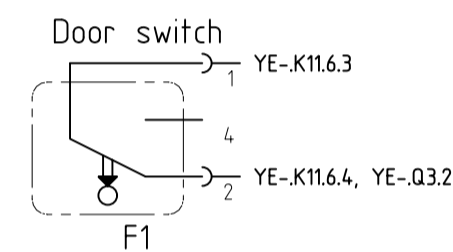
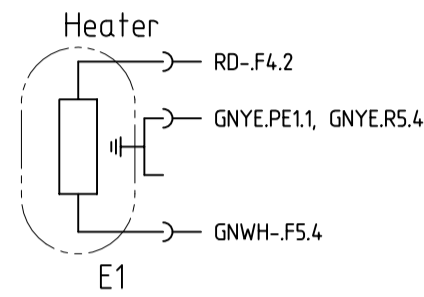
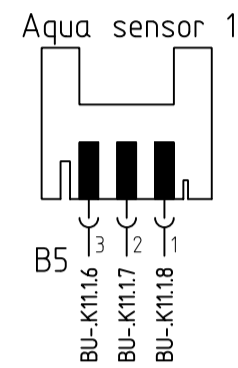
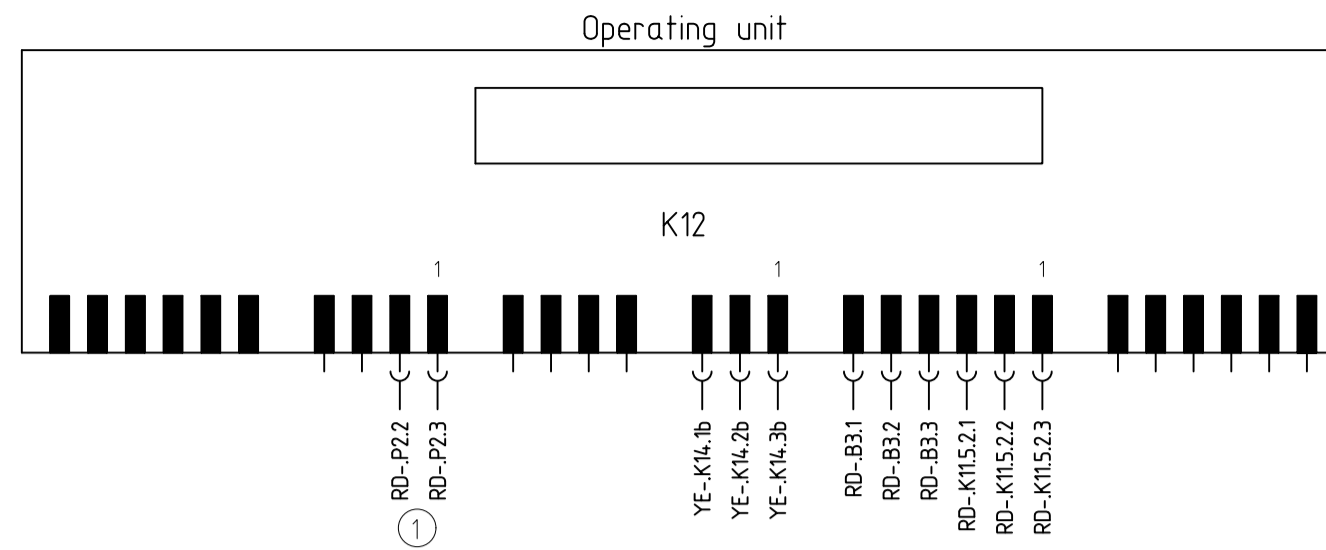
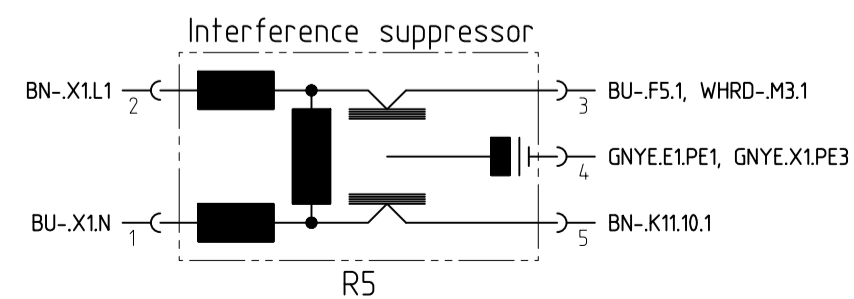
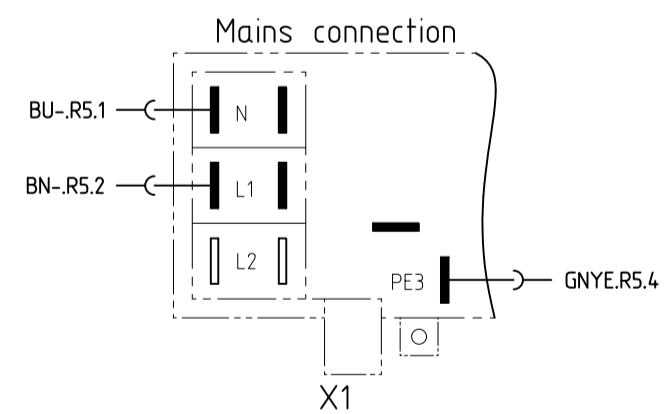
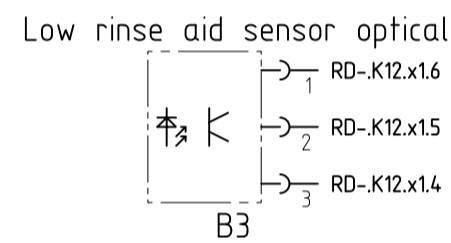
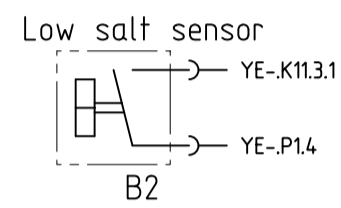
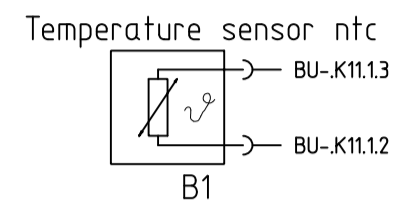
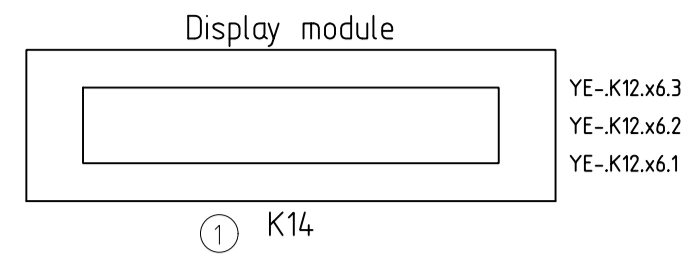

① Fitted depending on features

The reproduction, transmission or use of this document or its contents is not permitted without express written authority. Offenders will be liable for damages. All rights including rights created by patent grant or registration of a utility model or design are reserved. Copyright reserved.

Customer service test programme

1. Selecting the model coding:

Open the door; switch off the appliance; simultaneously press and hold down the two right sensor buttons “E and F”; also press sensor button “A” for at least 3 sec.

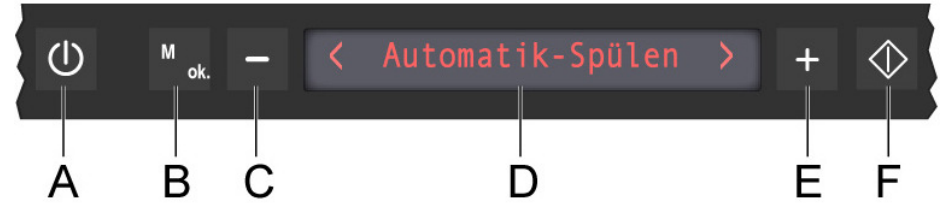

2. Select special programme:

Select the Customer – Service (S3) special programme by pressing the sensor buttons “C und E” and acknowledge with button “F”.

3. Display the fault memory:

If the Customer Service programme is started via sensor button “F”, the fault memory of the last wash cycle is indicated via the display. The fault memory of the last 8 wash cycles can be read out via the +/- buttons. S3 for Customer Service programme, the fault code and the wash cycle are displayed.



4. Start the customer service programme:

When the fault memory has been displayed, the customer service programme is started by closing the door.

Programme steps can be skipped with the + button. Exception are the filling steps. S3 for Customer Service programme, the fault code and the programme step are displayed.

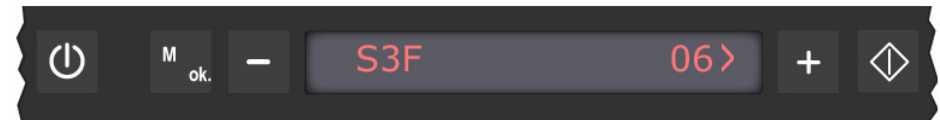

While the customer service programme is selected, each status change of the analogue signal inputs is acknowledged by the electronics module with an acoustic signal.

Document No. 56000000134930 ASP EN A	Rev. A	Sheet-No. 1 of 3
Material No. 9000 115 674	GV638 , T , WT, Sibusym	

5. Fault code:

Fault code	Fault type
A	Aqua sensor calibration fault infrared measuring distance
B	Aqua sensor calibration fault green measuring distance
C	No tachimpulses
D	Triac short-circuit, circulation pump
E	Water points, no switching impulses
F	Filling fault
G	Triac short-circuit, water points
H	Heating fault
I	---
J	---
K	NTC fault, interruption / short-circuit
L	Optical sensor, fault or no communication
M	---
N	Mains synchronisation not possible
O	Safety level detected
P	Safety level (O) detected 8 times

6. Abbreviations for programme sequence:

AWT= Heat exchanger outlet valve

FRW = Fill raw water

FWW= Fill soft water

H= Heat

AS_IR= IR Aqua sensor

P= Pump

Pa = Pause

R= Regeneration valve

U= Circulate

AS_GN= GN Aqua sensor

WS = Alternate washing

WWP = Position water points

WK = Switch between UK / OK

VF = Prefill heat exchanger F1

ZR= Dispense detergent

ZK= Dispense rinse aid

OK = Top basket

UK = Bottom basket

Document No. 56000000134930 ASP EN A	Rev. A	Sheet-No. 2 of 3
Material No. 9000 115 674	GV638 , T , WT, Sibrusym	

7. Sequence of the customer service test programme:

	Function	Time (s)	Temperature	Quantity	Rinsing kind	Sensor	r.p.m. UK	r.p.m. OK	r.p.m. WK	Time [s] OK/UK
0	P	30								
1	FWW			1,0 l						
2	Pa	2								
3	FRW			1,0 l						
4	Pa	2								
5	VF					F1				
6	AWT	10								
7	AWT+ AS_IR+ AS_GN	30								
8	AWT + U (Activation SIBRUSYM)	25								
9	AWT + R	5								
10	U + H + ZR	90					maximal			
11	WWP				OK					
12	Pa	2								
13	WWP				UK					
14	U	30					maximal			
15	WWP				OK					
16	U	20			OK			2250		
17	U + H + ZK	90			WS		2500	1500	2000	15 / 15
18	U + H		60°		WS		2900	2250	2900	60 / 50
19	AWT + P + FWW	30								
20	U + FWW	90		0,8 l			maximal			
21 - 26	WP + WWP	30			UK					
27	P	45								
00	End of programme									

Note: In Pos. 18 the circulation pump is activated for top basket washing at 1500 r.p.m. only. At this speed the upper spray arm cannot rotate or can rotate only very slowly. When the water points are positioned, the position switch is actuated 4 times whenever there is a change from OK to UK (or UK to OK). Whenever the position switch is actuated, an acoustic signal sounds.

Document No. 56000000134930 ASP EN A	Rev. A	Sheet-No. 3 of 3
Material No. 9000 115 674	GV638 , T , WT, Sibrusym	