

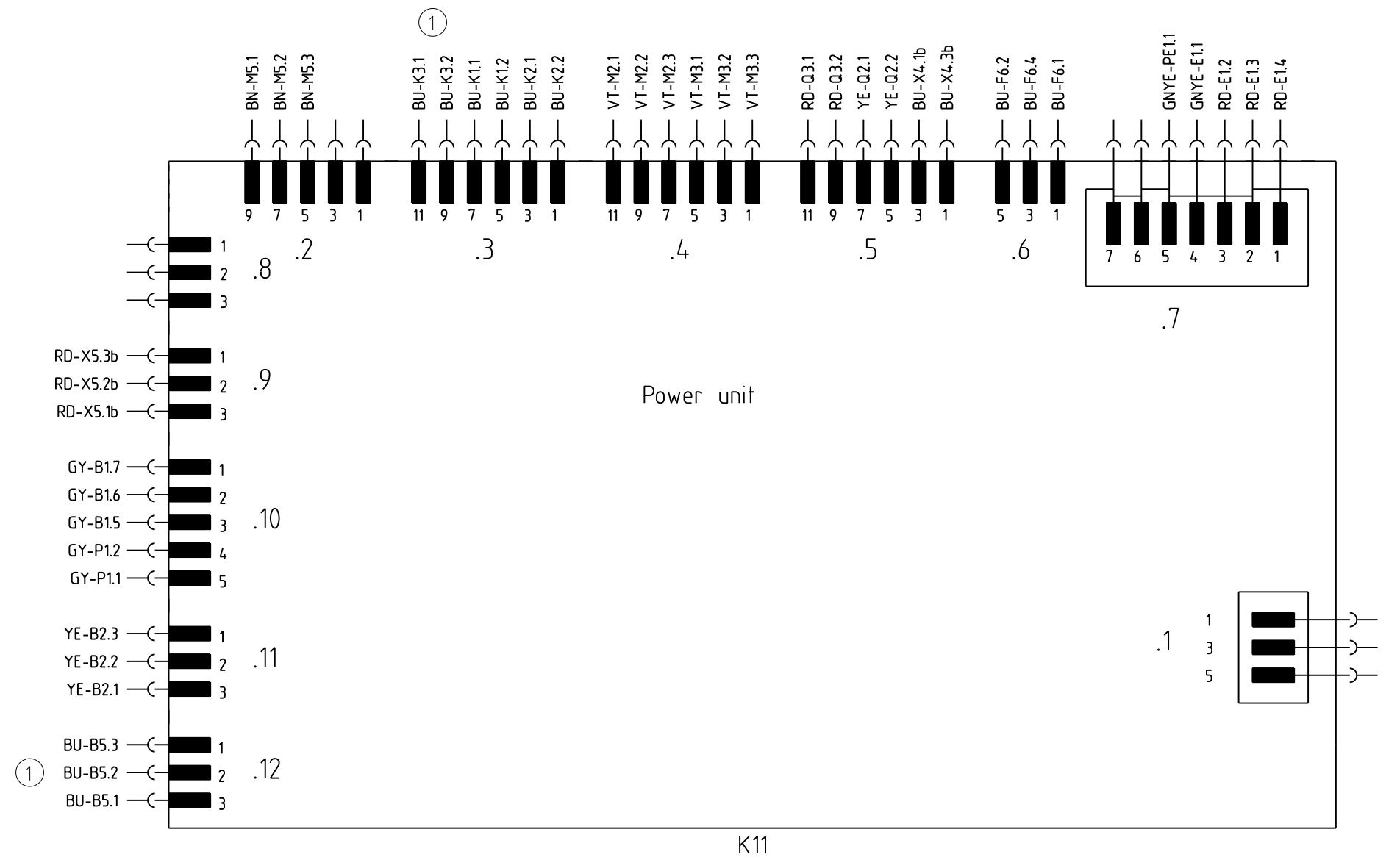

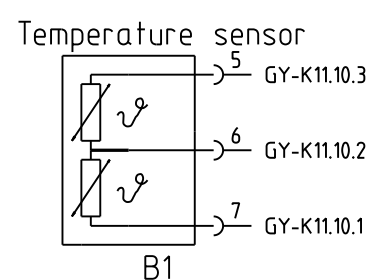

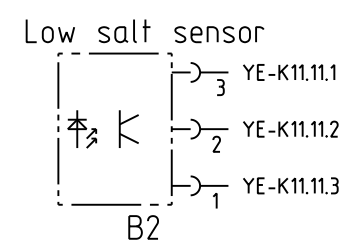

Low rinse aid sensor

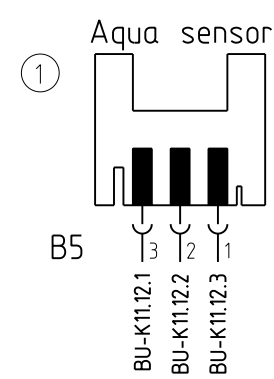
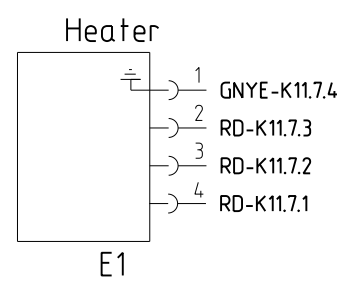
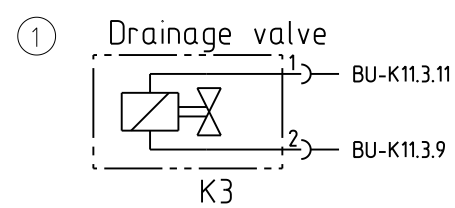
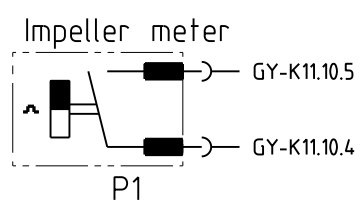
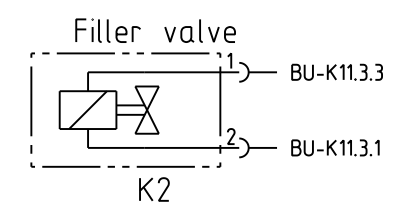
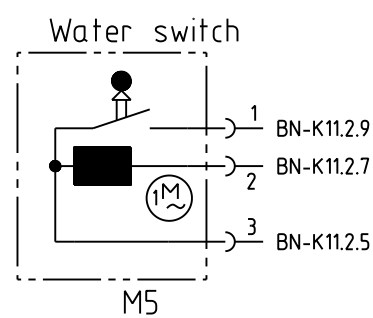
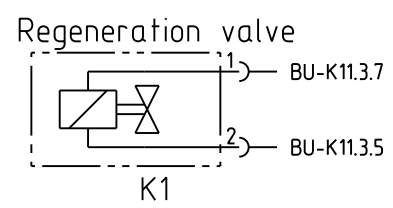
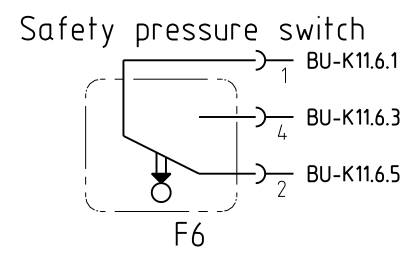
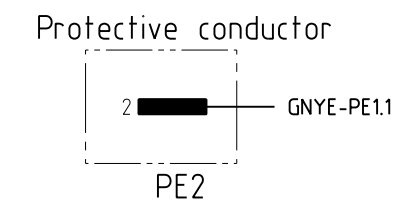
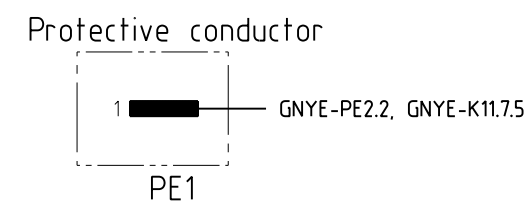
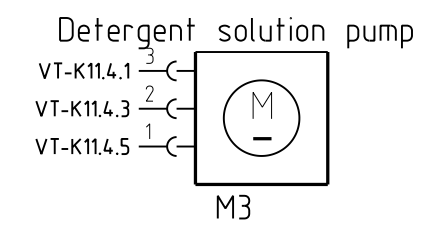
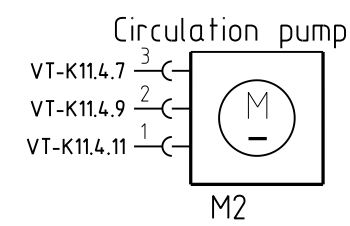
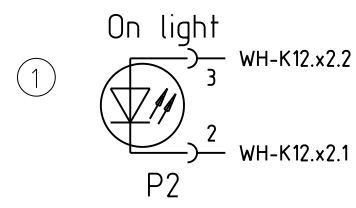
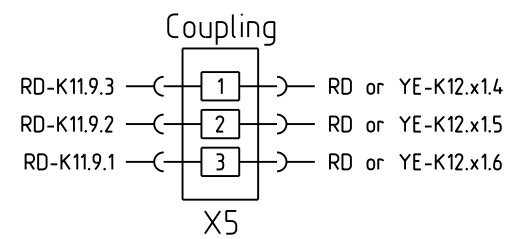
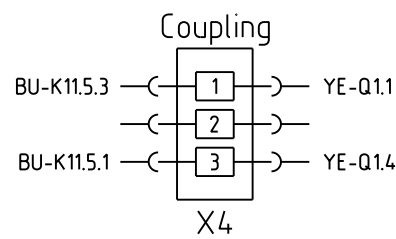
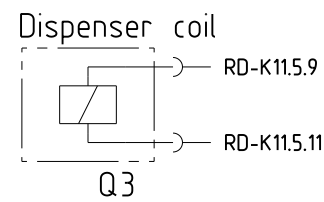
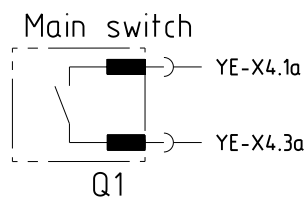
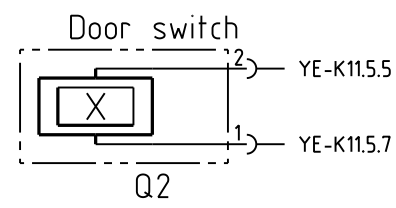
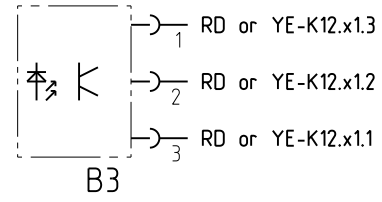
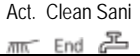

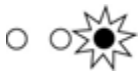



① Fitted depending on features

Function	Actuation	Display	Remark
----------	-----------	---------	--------

Fault group		In the test programme		At the customer		Appliance behaviour if fault occurs	Results of the internal appliance test	Measures
		LED's	Display	LED	Display			
		Act. Clean Sani 						
			E:00				<i>Not a fault</i>	
Power module			E:01		E:01	→ End of programme	Pump actuation or pump switchover defective.	Replace power module.
			E:02		E:02	Operation without heater.	Working relay for heater defective.	
			E:03		E:03	→ End of programme	Working relay/safety relay for heater defective.	
			E:04			Reserved		
			E:05		E:05	Programme stopped with draining, water switch run continuously.	Triac for water switch motor defective.	
Door			E:06		E:06	Stop in current position, no appliance function possible.	Hall sensor defective, cable interrupted or power module defective.	Power module in working order if supply voltage is already at the removed Hall sensor plug. Otherwise change Hall sensor.















Document No. 5600 00000157007 ASP EN D	Rev. D	Sheet-No. 1 of 4
Material No. 9000 361 479		

Function	Actuation	Display	Remark
----------	-----------	---------	--------

Fault group		In the test programme		At the customer		Appliance behaviour if fault occurs	Results of the internal appliance test	Measures
		LED's	Display	LED	Display			
		Act. Clean Sani  End 						
Heating			E:07			Operation without auxiliary drying system.	Heating circuit interrupted, fan defective, auxiliary electronics defective, cables interrupted.	Test components (applies to appliances with auxiliary drying system only).
			E:08			Operation without heater	Circulation pump detects too low water level in pump sump.	Start test programme, check filling. Leaks? Bowls/pans overturned in the appliance?
			E:09		E:09		Heating circuit interrupted (resistor, supply cables, contacts of the safety relay on power module).	Measure heating resistors. Check cables.
			E:10				Heat emission too low, deposits on heater.	Test water hardness; if required, descale/clean. If repeated, replace heat pump.
			E:11		E:11		NTC fault Fault in supply cable NTCs.	Measure NTCs. Check cables.
			E:12				Reserved	
			E:13				Water temperature too high (> 75 °C)	Protective measure – not a fault, check water supply temperature.







Document No. 5600 00000157007 ASP EN D	Rev. D	Sheet-No. 2 of 4
Material No. 9000 361 479		

Function	Actuation	Display	Remark
----------	-----------	---------	--------

Fault group		In the test programme		At the customer		Appliance behaviour if fault occurs	Results of the internal appliance test	Measures
		LED's	Display	LED	Display			
		Act. Clean Sani  End 						
Fill		  	E:14		E:14	Programme stopped with draining	No impulses from flow sensor, although water detected by circulation pump.	Check cables, test flow sensor (reed switch).
			E:15		E:15	Programme stopped with intermittent pumping	Base pan safety switch active. Appliance cannot be switched off.	Search for cause of water in the base pan.
			E:16		E:16			
			E:17		E:17	Programme stopped with draining	Water supply rate too high according to flow sensor.	Check flow controller in the filling valve.
			E:18			Wait for supply; programme stopped with draining	Water supply rate too low according to flow sensor or no water supply.	Check water supply.
Circulation pump		  	E:19				Reserved	
			E:20		E:20	→ End of programme	Resistance values of circulation pump wrong.	Check cables, measure windings.
			E:21		E:21	→ End of programme	Circulation pump blocked	Check for foreign objects, if required replace.

Document No. 5600 00000157007 ASP EN D	Rev. D	Sheet-No. 3 of 4
Material No. 9000 361 479		

Function	Actuation	Display	Remark
----------	-----------	---------	--------

Fault group		In the test programme		At the customer		Appliance behaviour if fault occurs	Results of the internal appliance test	Measures
		LED's	Display	LED	Display			
		Act. Clean Sani 						
Detergent-solution pump			E:22				Reserved	
			E:23		E:23	→ End of programme	Resistance values of drain pump wrong.	Measure windings, check cables.
			E:24		E:24	→ End of programme	Draining not possible. Missing cover?	Check water drainage (hose kinked, blocked, delivery head, pump cover). Attach cover.
			E:25		E:25	→ End of programme	Drain pump blocked; perhaps missing cover.	Check for foreign objects. Attach cover.
Water points			E:26			Water points actuated continuously	No impulses from water points despite actuation.	Check the line. Measure mains voltage on the motor. Test water points switch.
			E:27				Reserved	
AquaSensor			E:28			Operation without AquaSensor	Calibration of AquaSensor not successful.	Check cables. AquaSensor dirty. AquaSensor available as standard for this appliance?
In-house			E:29				Reserved	
			E:30			Normal operation	Overvoltage	Not relevant to customer service
			E:31				Circulation pump overloaded	Not relevant to customer service
			E:32				Drain pump overloaded	Not relevant to customer service

Function	Actuation	Display	Remark
----------	-----------	---------	--------

		Display	Can be skipped?	Time (s)	Value	Check Measure	Remark
Preparation						Remove approx. 0.5 l water from salt dispenser.	Regeneration valve must be checked for leaks at appropriate customer specifications (see also steps with display S:11 + S:33).
CoilCheck		S:00	No	approx. 20			Check the drain pump. Activate the drain pump and place the water switch in the top basket position.
Check flow sensor and flow controller		S:01 – S:03 (Step S:04 to S:06 are displayed only if error occurs E 18)	No	approx. 10–100			Add 50 ml (filling valve, drainage pump and circulation pump are activated in succession).
Pause		S:07 (Step is not displayed)	Yes	10			
Fill + pump		S:08–S:10	No	approx. 100			Residual quantity in the pump sump is pumped off.
Pause		S 11	Yes	10		Visual inspection: water level in salt dispenser.	No change to water level ==> Regeneration valve leakproof.
Fill		S 12	No	approx. 36	1.5 l		All the water is conveyed to the pump sump.
Pause		S 13	Yes	10		Visual inspection: water level in appliance.	Water level on upper edge of fine mesh filter (= 1.5 l in pump sump).

Document No. 56000000162697 ASP EN B	Rev. B	Sheet-No. 1 of 3
Material No. 9000 347 372	GV640 WE	

Function	Actuation	Display	Remark
----------	-----------	---------	--------

		Display	Can be skipped?	Time (s)	Value	Check Measure	Remark
Fill		S:14–S:15	No	approx. 60	2.5 l		Total: 4 l in appliance
Circulate		S 16	Yes	15			Circulation pump must not “snorkel”.
Dispense (detergent)		S 17	Yes	10			
Circulate + heat + calibrate AquaSensor		S:18–S:19	No	110			
Circulate + heat		S 20	Yes		40 °C		During heating +2.5 °C/min.
Pause		S 21	Yes	5			
Circulate + dispense (rinse aid)		S:22–S:24	Yes	65			Number of impulses = set value of dispensed rinse aid.
Circulate + heat + change position of water switch		S:25–S:26	Yes	approx. 480	65 °C		During heating +2.5 °C/min. Change every 30 s roof shower head, top basket, bottom basket.
Pump off		S 27	No	45			
Pause		S 28	Yes	60			Pause
Pause		S 29	Yes	10		Visual inspection: water level in appliance.	Water level must be over handle of coarse filter.
Pump off + fill + regenerate		S:30–S:32	No	approx. 20			Drain the complete appliance.
Pause		S 33	Yes	10		Visual inspection: water level in salt dispenser.	Water level in salt dispenser must be increased by several cm.
Pump + fill		S:34–S:35	No	approx. 96	4 l		Rinse the brine solution out of the pump sump.

Document No. 56000000162697 ASP EN B	Rev. B	Sheet-No. 2 of 3
Material No. 9000 347 372	GV640 WE	

Function	Actuation	Display	Remark
----------	-----------	---------	--------

		Display	Can be skipped?	Time (s)	Value	Check Measure	Remark
Pump		S 36	No	30			Drain the complete appliance
Check whether appliance was drained (activates circulation pump and drain pump)		S:37–S:38 (Step S:39 to S:40 are displayed only if error occurs E 24)	No	approx. 10–120			Self-check whether appliance was drained.
End of test programme		“0” on display or “End LED” is lit				Switch off main switch	Test has ended. When the appliance is next switched on, the normal rinse programme is displayed.
Stop						Perform reset	Is possible at any time by pressing the Start/Stop button for longer than 3 seconds.

Document No. 56000000162697 ASP EN B	Rev. B	Sheet-No. 3 of 3
Material No. 9000 347 372	GV640 WE	

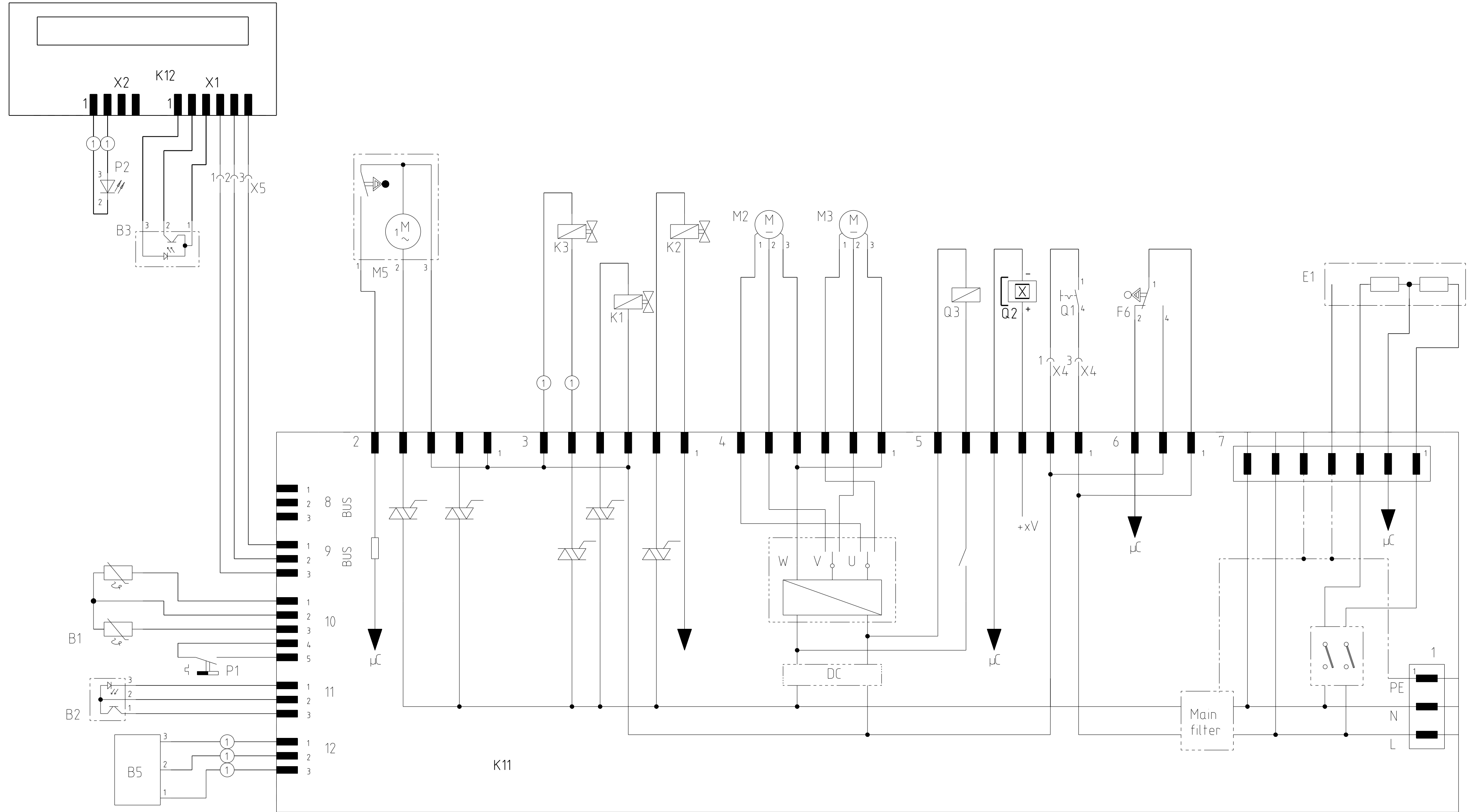

1 2 3 4 5 6 7 8 9 10 11 12 13 14 15 16 17 18 19 20 21 22 23 24 25 26 27 28 29 30 31 32 33 34 35 36 37 38 39 40 41 42 43 44 45 46 47 48 49 50 51 52 53

REF	Components	Path	REF	Components	Path
B1	Temperature sensor NTC	5	P2	On light	3
B2	Low salt sensor optical	4	Q1	Main switch	38
B3	Low rinse aid sensor optical	5-6	Q2	Door switch	36
B5	Aqua sensor 1	6	Q3	Dispenser coil	34
E1	Heater	47,48,50,51			
F6	Safety pressure switch	40-41			
K1	Regeneration valve	22			
K2	Filler valve	24			
K3	Drainage valve	20			
K11	Power unit	9-51			
K12	Operating unit T	3-8			
M2	Circulation pump BLDC	26-27			
M3	Detergent solution pump BLDC	29-30			
M5	Water switch	12-15			
P1	Impeller meter	6-8			

① Fitted depending on features

The reproduction, transmission or use of this document or its contents is not permitted without express written authority. Offenders will be liable for damages. All rights including rights created by patent grant or registration of a utility model or design are reserved. Copyright reserved.