



















① Fitted depending on features



Designation Connection Diagram GV640 II. Gen	LCS EN	Document No. 5600 0001074481	Rev B	Sheet-No. 1 of 1
		Material No. 9000505353		

Function	Actuation	Display				Remarks			
Error class (failure group)		In Customer Service program		At Customer		Appliance behaviour in error case	Results of internal appliance check	Measures	
		LED's	Display	LED	Display				
		Act. Clean Sani End							
		○ ○ ○	E:00				No error		
Interface						Blinking LED's at end of Flash process Stop in current position, no function	Communication issue within electronics	Power cord of the appliance has to be disconnected (to activate on/off from main switch is not enough!) > Verify D-Bus - connectors (3-pole) for electrical connection failure; > Disconnected power cord (plug out and then again plug in); > Repeat flash process; > Change Modul	
Power module		○ ○	E:01			E:01	→ End of program	Pump triggering or pump switching is defect	Change power module
			E:02			E:02	Running w/o heating	Working relay of heating is defect	
			E:03			E:03	Running w/o additional drying system.	Working relay of additional drying system is defect.	
			E:04			E:04	Running w/o heating	Safety relay of heating is defect	
			E:05			E:05	Water switch is running permanently Cancelation of program (Drain)	Impulses w/o activation Water switch triac defect	

Function	Actuation	Display				Remarks			
Error class (failure group)		In Customer Service program		At Customer		Appliance behaviour in error case	Results of internal appliance check	Measures	
		LED's	Display	LED	Display				
		Act. Clean Sani End		 					
Door			E:06		E:06	Stop in current position, no function	Hall-sensor defect, wire disconnected or power module defect	Power module is functional ok, if plug is disconnected and Hall-sensor is feed with supply voltage. Otherwise change Hall-sensor.	
Heating			E:07		E:07	Function w/o additional drying-system.	Fan defect/blocked Fanelectronic defect	Check component / connection / Measure resistance => only dishwashers with additional drying system	
			E:08			Function w/o heating.	Heat pump detects too low water level in sump. Low voltage	>heat exchanger drain valve is leaky >Overturned bowls / pots in appliance? No device error!	
			E:09		E:09			Heating-circuit is intermittent (resistance, wire harness, safety relais pins on power module)	Measure heating resistance, check wires
			E:10			Function w/o additional drying-system.	Heating-circuit additional drying system is intermittent (resistance/wire harness) Fanelectronic defect Failure in wire to fan	Check water hardness; if necessary decalcify and clean. On repeat change heat pump. Check component Connection? => only dishwashers with additional drying system	
			E:11		E:11	Function w/o heating.	NTC-failure Failure in wire to NTC's	Measure NTC's, check wires.	
			E:12					Reserved	

Function	Actuation	Display				Remarks		
Error class (failure group)		In Customer Service program		At Customer		Appliance behaviour in error case	Results of internal appliance check	Measures
		LED's	Display	LED	Display			
		Act. Clean Sani End						
			E:13				Water temperature too high (> 75°C)	Safety measure - no failure! Check water inlet temperature .

Function	Actuation	Display	Remarks					
Error class (failure group)		In Customer Service program		At Customer		Appliance behaviour in error case	Results of internal appliance check	Measures
		LED's	Display	LED	Display			
		Act. Clean Sani End						
Filling		 	E:14		E:14	Program abort with draining	Flow sensor detects no impulses, even though circulation pump detects water.	Check wires, check flow sensor (Reed-switch)
			E:15		E:15	Program abort with interval pumping	Safety switch base carrier active. Appliance can't be turned off.	Look / Search for cause of water in base carrier
			E:16		E:16		Water inlet (impulses from flow sensor) w/o activation of filling valve.	Check filling valve. Check triggering of filling valve.
			E:17		E:17	Program abort with draining	Water inlet amount according flow sensor too high	Check flow control in filling valve
			E:18			Waiting for water inlet. Program abort with draining	Water inlet amount according flow sensor too low or no water intake.	Check water inlet
Circulation pump		 	E:19				Reserved	
			E:20		E:20	→ End of program	Wrong resistance value of circulation pump	Check wires, measure coil.
			E:21		E:21	→ End of program	Circulation pump blocked	Check for foreign objects, if necessary renew
Drainpump		 	E:22		E:22	→ End of program	Water in pump sump, because of dirt filters.	Clean filters.
			E:23		E:23	→ End of program	Wrong resistance value of drain pump	Check wires, measure coil
			E:24		E:24	→ End of program	Draining not possible. Pump cover missing?	Check water draining (hose kinked / blocked, pressure head, pump cover). Install pump cover. Inspect check valve
			E:25		E:25	→ End of program	Drain pump blocked; possibly pump cover is missing	Check for foreign objects. Install pump cover

Function	Actuation	Display				Remarks		
Error class (failure group)		In Customer Service program		At Customer		Appliance behaviour in error case	Results of internal appliance check	Measures
		LED's	Display	LED	Display			
		Act. Clean Sani End						
Waterswitch			E:26			Permanent activation of water switch	Impulses from water switch are missing despite triggering	Check wires. Measure supply voltage on motor. Check switch of water switch
			E:27					Reserved
Aquasensor			E:28			Function w/o aquasensor	Calibration of aquasensor not successful	Check wires. Dirt on aquasensor. Is appliance serially equipped with aquasensor?
General			E:29			No correct functions / Bad washing/drying result possible	Lowvoltage (<190V)	No device error!
			E:30			Dishwasher switches off themself	Overvoltage (>290V)	No device error!
			E:31				Reserved	
			E:32				Reserved	

The reproduction, transmission or use of this document or its contents is not permitted without express written authority. Offenders will be liable for damages. All rights including rights created by patent grant or registration of a utility model or design are reserved. Copyright reserved.

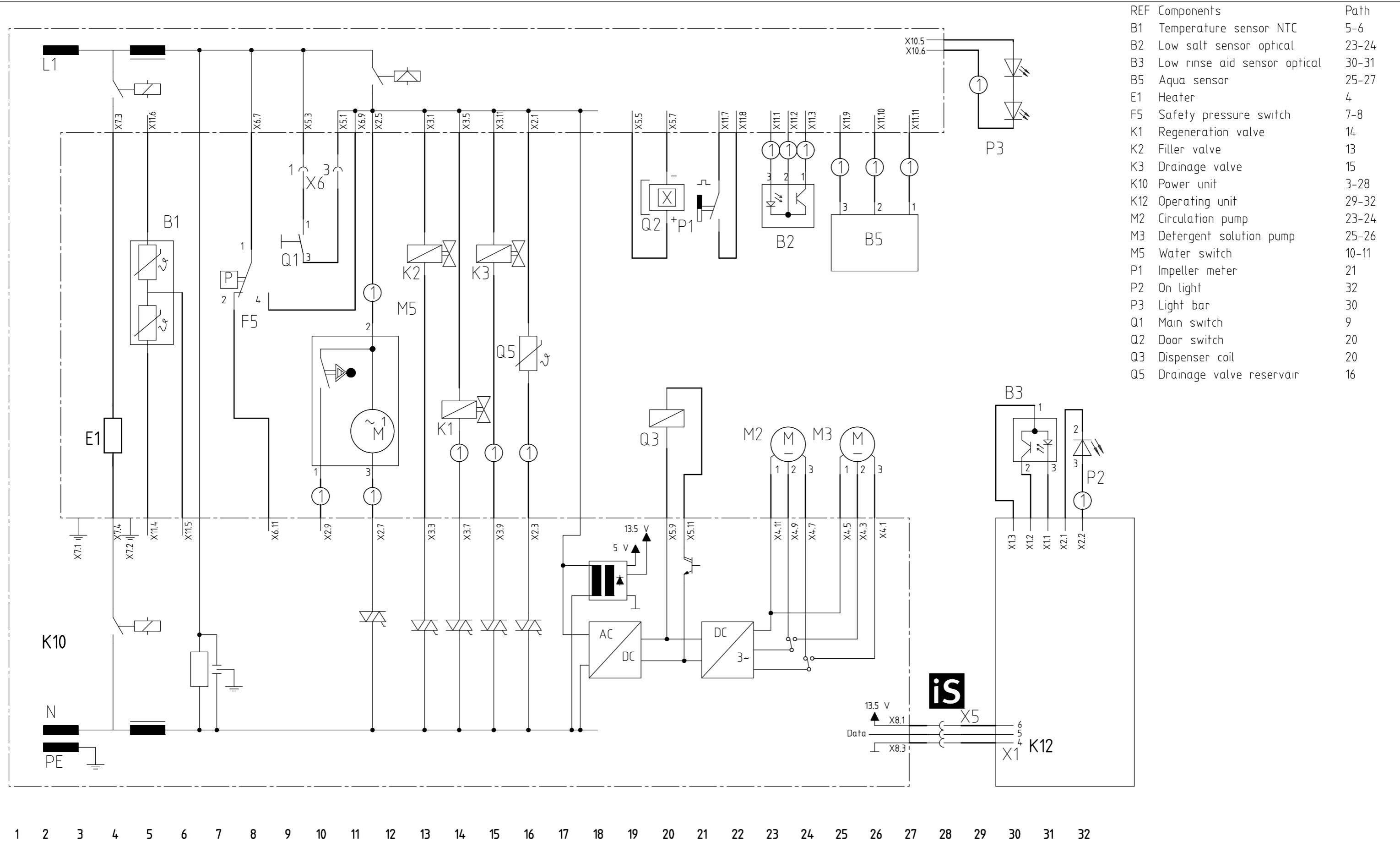

REF	Components	Path
B1	Temperature sensor NTC	5-6
B2	Low salt sensor optical	23-24
B3	Low rinse aid sensor optical	30-31
B5	Aqua sensor	25-27
E1	Heater	4
F5	Safety pressure switch	7-8
K1	Regeneration valve	14
K2	Filler valve	13
K3	Drainage valve	15
K10	Power unit	3-28
K12	Operating unit	29-32
M2	Circulation pump	23-24
M3	Detergent solution pump	25-26
M5	Water switch	10-11
P1	Impeller meter	21
P2	On light	32
P3	Light bar	30
Q1	Main switch	9
Q2	Door switch	20
Q3	Dispenser coil	20
Q5	Drainage valve reservoir	16

① Fitted depending on features

Designation Circuit Diagram GV 640 II Generation	LCS EN	Document No. 5600 0001073685	Rev B	Sheet-No. 1
		Material No. 9000505352		of 1