

The reproduction, transmission or use of this document or its contents is not permitted without express written authority. Offenders will be liable for damages. All rights including rights created by patent grant or registration of a utility model or design are reserved. Copyright reserved.

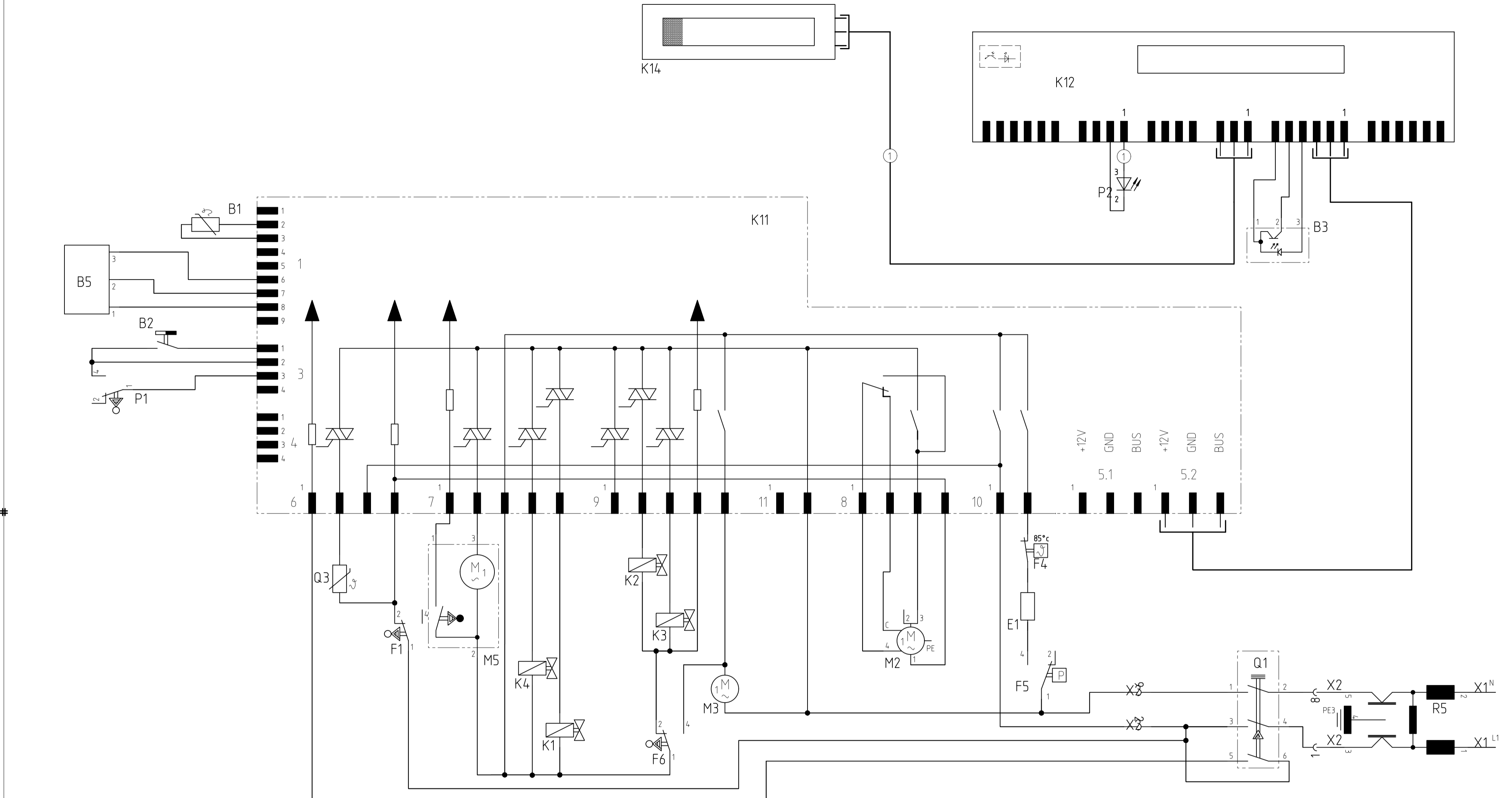

1 2 3 4 5 6 7 8 9 10 11 12 13 14 15 16 17 18 19 20 21 22 23 24 25 26 27 28 29 30 31 32 33 34 35 36 37 38 39 40 41 42 43 44 45 46 47 48 49 50 51 52 53 54 55

REF	Components	Path
B1	Temperature sensor ntc	7,9
B2	Low salt sensor	6,8
B3	Low rinse aid sensor optical	46-48
B5	Aqua sensor 1	5
E1	Heater	38
F1	Door switch	15,16
F4	Safety thermostat	38
F5	Safety pressure switch	38,39
F6	safety pressure switch	24,25
K1	Regeneration valve	21
K2	Filler valve	24
K3	Drainage valve	25
K4	Raw water valve	20
K11	Power unit	10,12-15,17-21,23-27,29,30,32-35,37,38,40-45
K12	Operating unit	40-50,52,53
K14	Display module	24,31

REF	Components	Path
M2	Circulation pump	33,34
M3	Detergent solution pump	27
M5	Water switch	17,18
P1	Level switch	4,6
P2	On light	41
Q1	Main switch	45,47
Q3	Dispenser actuator	13
R5	Interference suppressor	49,54

① Fitted depending on features

Designation Circuit Diagram AV638 X - Stg	LCS EN	Document No. 5600 0000133261	Rev A	Sheet-No. 1 of 1
To Request		Material No. 9000145324		

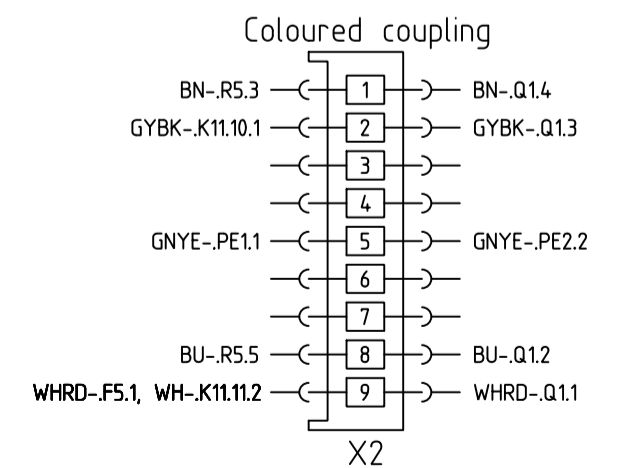
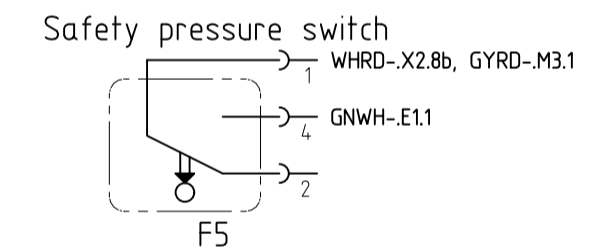
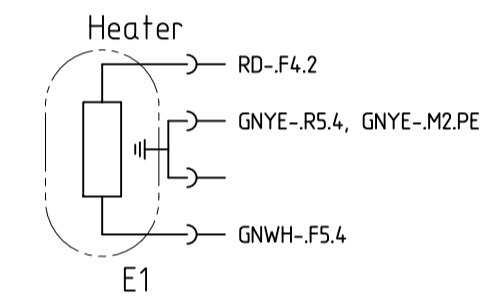
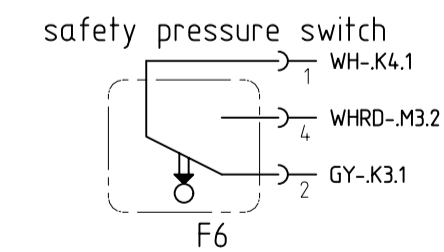
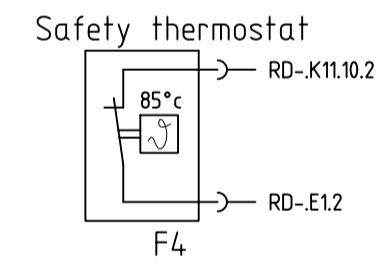
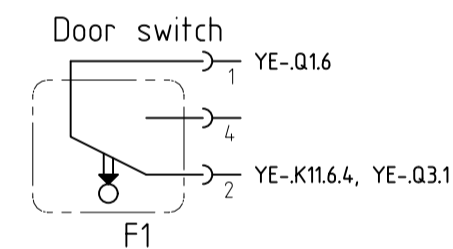
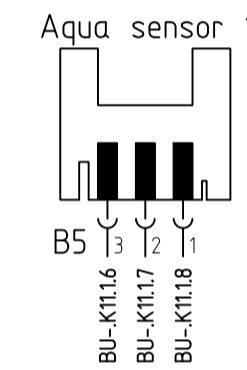
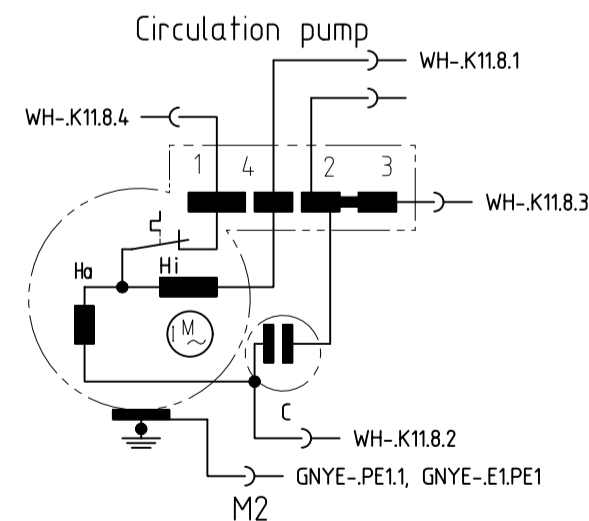
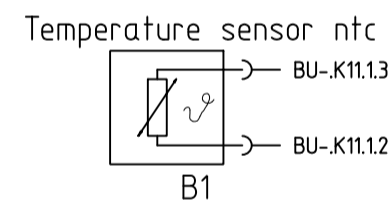
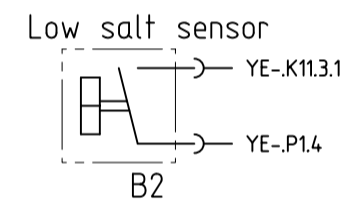
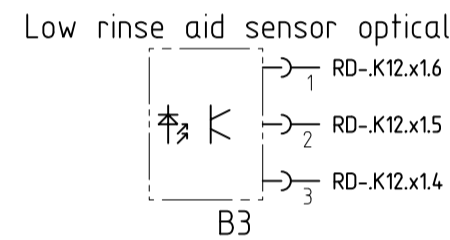
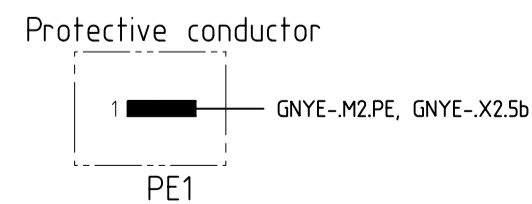
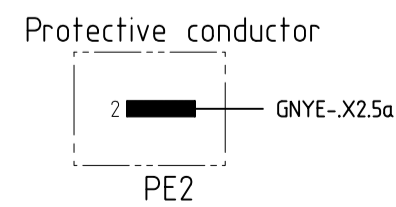
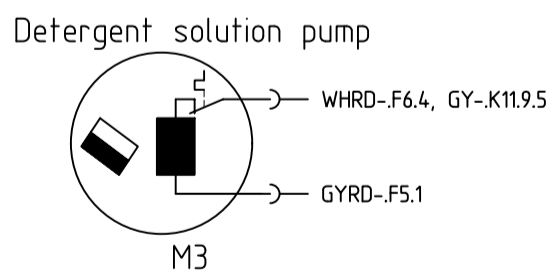
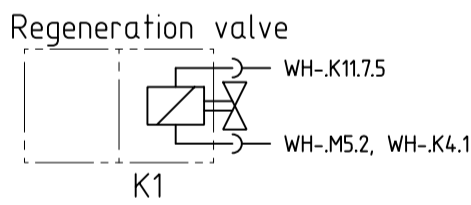
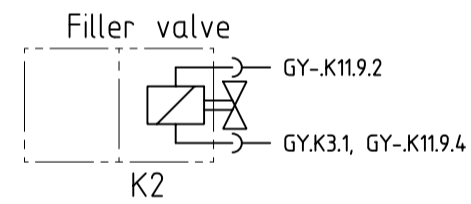
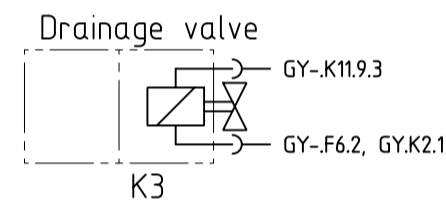
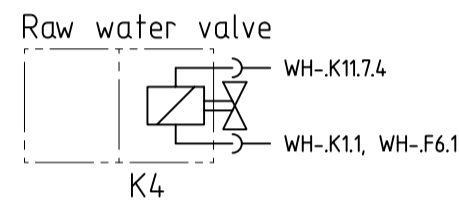
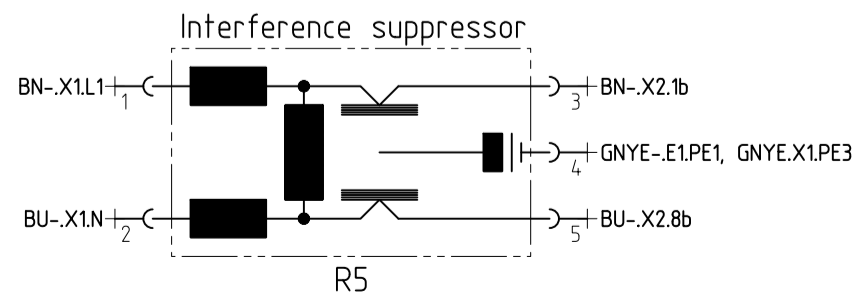
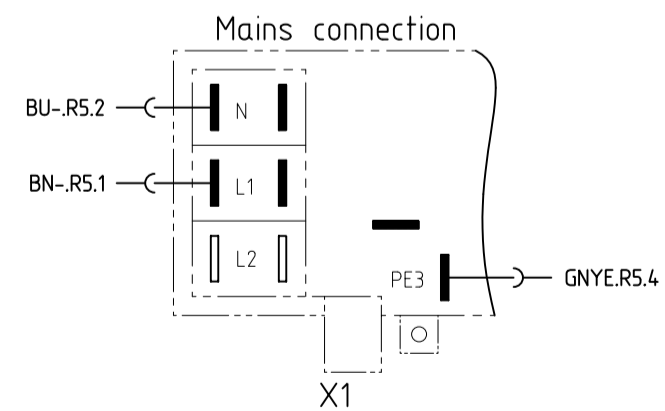
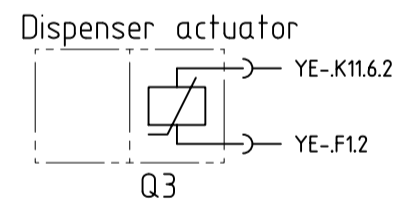
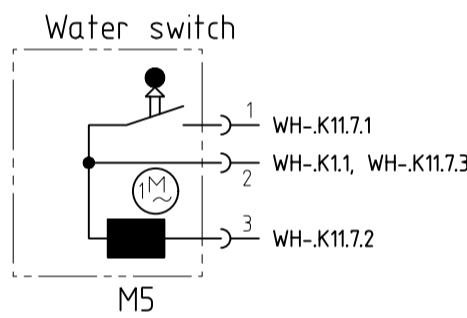
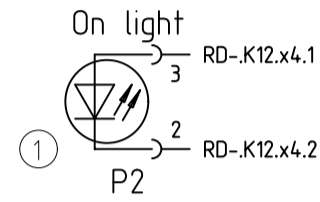
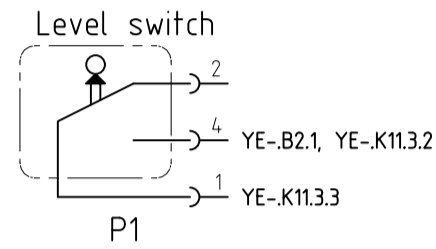
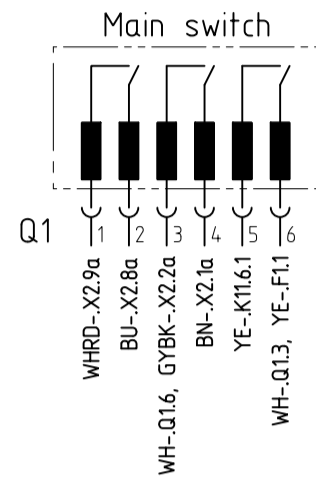
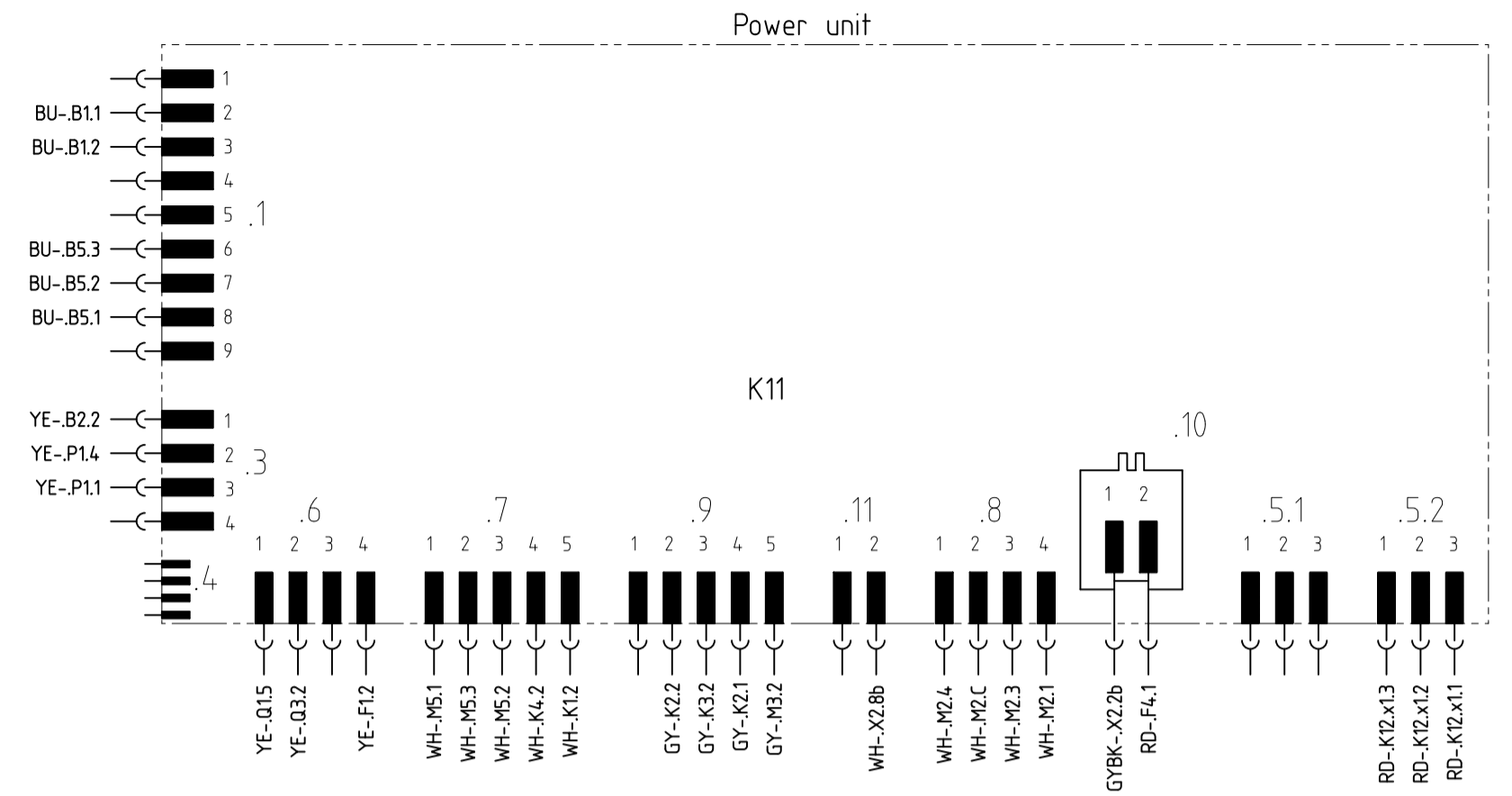
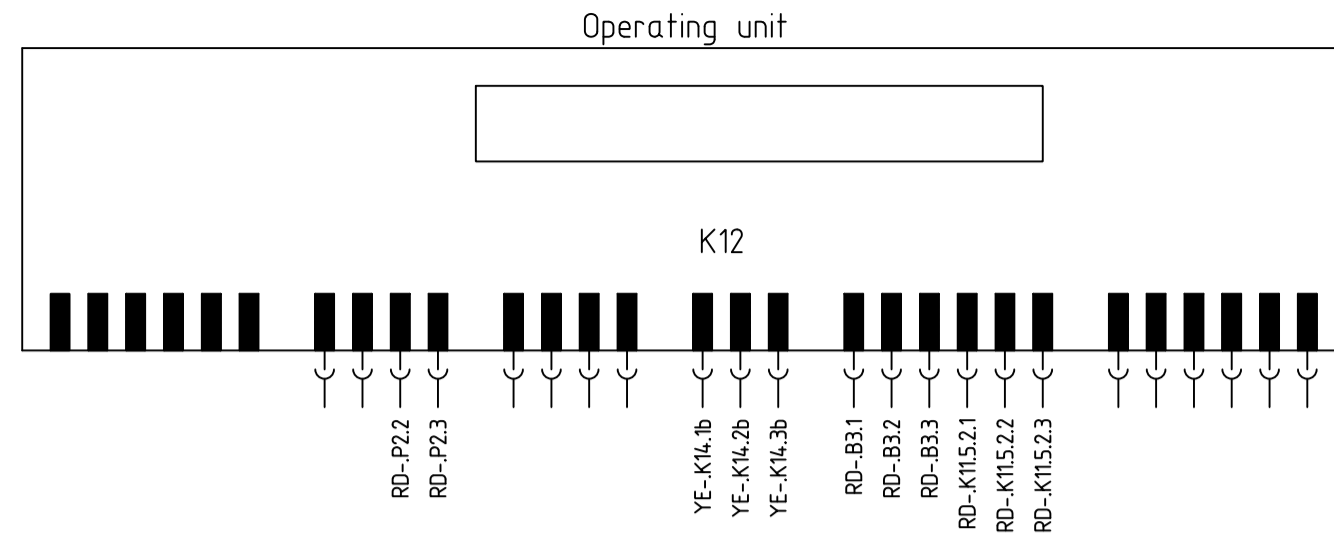
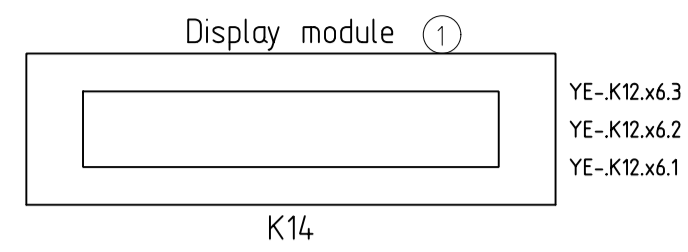

① Fitted depending on features

## Customer service test programme

### 1. Selecting the model coding:

- ▶ When the door is open, hold down any two programme buttons.
- ▶ Press the main switch until the model coding (e.g.: C2) is displayed.
- ▶ Release buttons, LED L3 comes on and LED L4 flashes, P0 is displayed.

### 2. Selecting the special programme:

- ▶ Press button S4 to activate the “read out fault memory” special programme

### 3. Read out fault memory (P0)

- ▶ Alternately press and release button S4. When the button is pressed, the rinse cycle is displayed (00–07) and when the button is released, the associated fault (see fault code table) is displayed.
- ▶ The faults of the last 8 rinse cycles can be queried
- ▶ If several faults occur in a rinse cycle, only the fault with the highest value is displayed.

### 4. Customer service test programme (P1)

- ▶ Press button S3, close the door, the customer service programme starts.
- ▶ Press button S3 to skip programme positions (exception: move to the next filling step by pressing filling switch F1 only)
- ▶ Each status change of the processor inputs is acknowledged by all LEDs lighting up briefly and an acoustic signal. (even water points position switch !)
- ▶ A fault which has occurred is indicated immediately via the display (heating fault after 10 minutes). If several faults occur, only the fault with the highest value is displayed. Following each repair a customer service test programme must be run to detect any other faults.
- ▶ The programme position is indicated via the display.

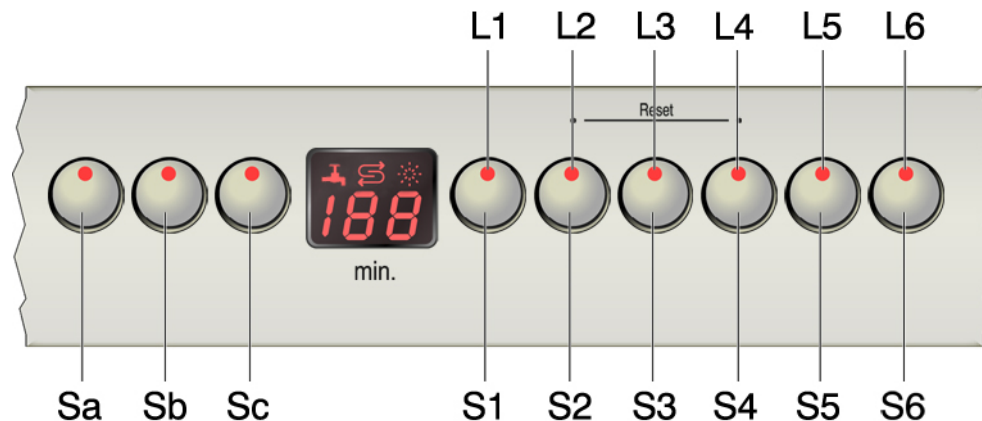

Document No. 56000000137026 ASP EN B	Rev. B	Sheet-No. 1 of 2
Material No. 9000 182 417	GV638, X	

## 5. Fault code

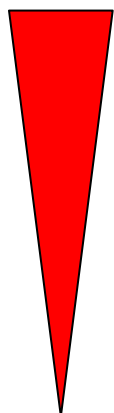
Fault code	Fault type	Value
E0	No fault	
E1	Heating fault	
E2	NTC fault	
E3	Filling fault	
E4	Water points cannot be positioned	
E5	Safety level reached	
E6	Aqua sensor (even if there is no Aqua sensor)	
E7	---	

	Symbol
AS_KAL	Calibrate Aqua sensor
AWT	Heat exchanger outlet valve
F	Filling the appliance
FWW	Filling with soft water
H	Heating
OK	Top basket
P	Pump
PA	Pause
R	Regeneration valve
SP	Intermittent pump
U	Circulate
VF	Prefill
WP	Alternate pumping
WS	Alternate rinsing
ZK	Dispense rinse aid
ZR	Dispense detergent

## 6. Sequence of the customer service test programme

	Function	Temperature	Time (s)	Sensor	Capacity	Rinse type
00	P		15			
01	VF			F1		
02	PA		5			
03	AWT		30			
04	U + AWT + F				3.9 l	
05	U + AWT		40			
06	U + H + ZR	max. 72 °C	120			WS throttled with OK
07	U + H	60 °C				WS
08	U + H + R	max. 72 °C°	120			WS
09	U + ZK		120			WS
10	AS_KAL		30			
11-16	WP		30			
17	P		45			
18	FWW + AWT		60			
19-24	SP		30			
25	P + AWT		30			
0	End					

Document No. 56000000137026 ASP EN B	Rev. B	Sheet-No. 2 of 2
Material No. 9000 182 417	GV638, X	