

Hauptschalter

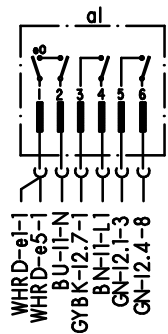

Anzeige - Bedienung + Steuermodul

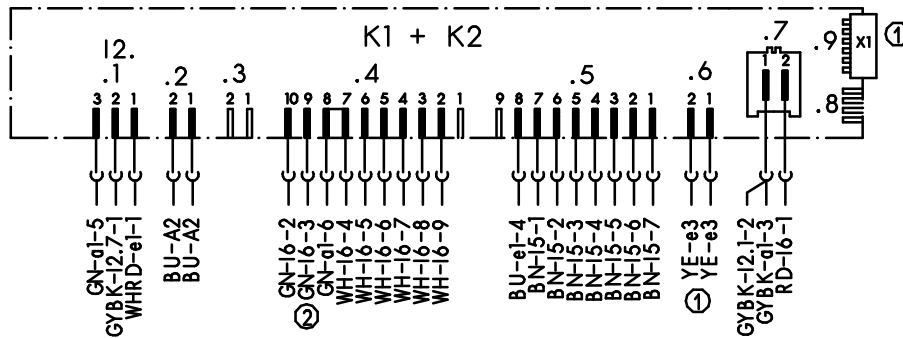

Reedschalter

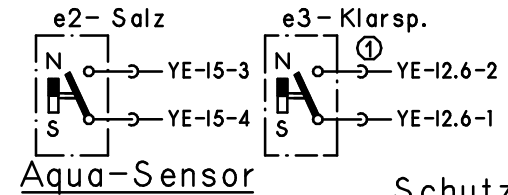

Aqua-Sensor

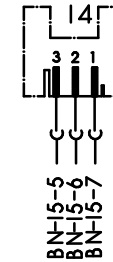

Schutzleiter

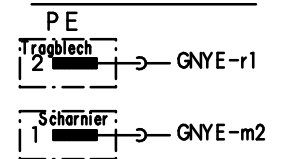

Tuerschalter

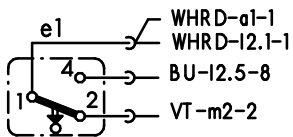

Niveaudruckdose

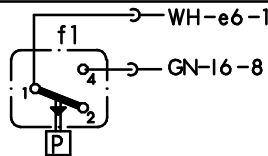

Temperaturregler + NTC

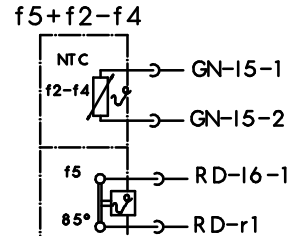

Schwimmersch.

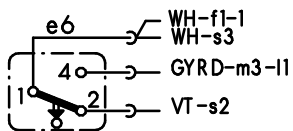

Magnetventile

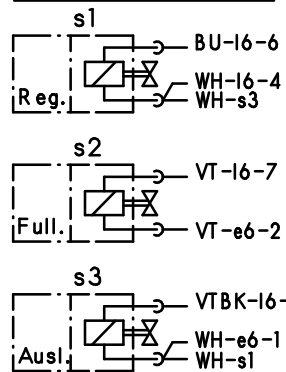

Kondensatormotor

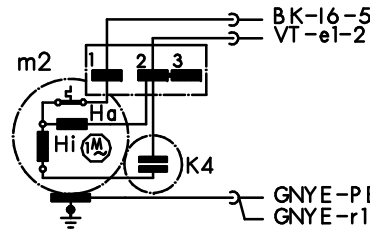

Aktuator



PTC-Motor

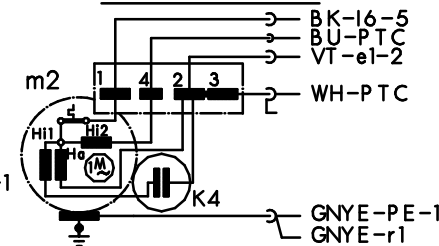

Kupplung

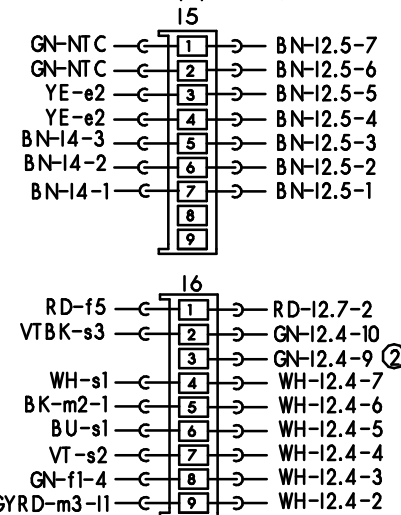

Kupplung

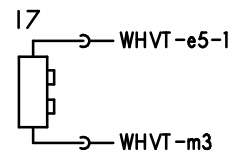

Klemme I1 mit Entstoerung

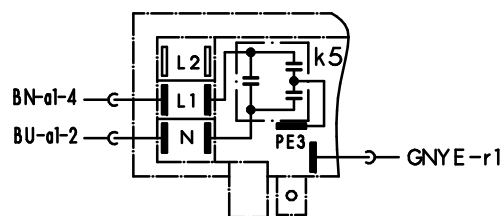

Heizung

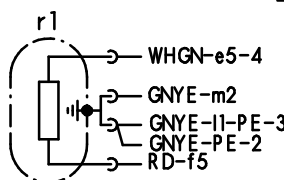

Sicherheitssch.

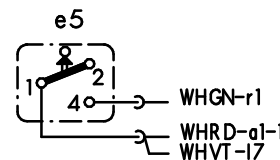

Laugenpumpe

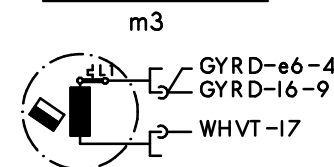

Anlaß-PTC

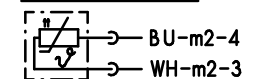

① je nach Ausstattung vorhanden
② wenn vorhanden ohne Funktion

③ je nach Motortyp



1 739 911 212	
Ausg.: 03.97	S0-60/0388

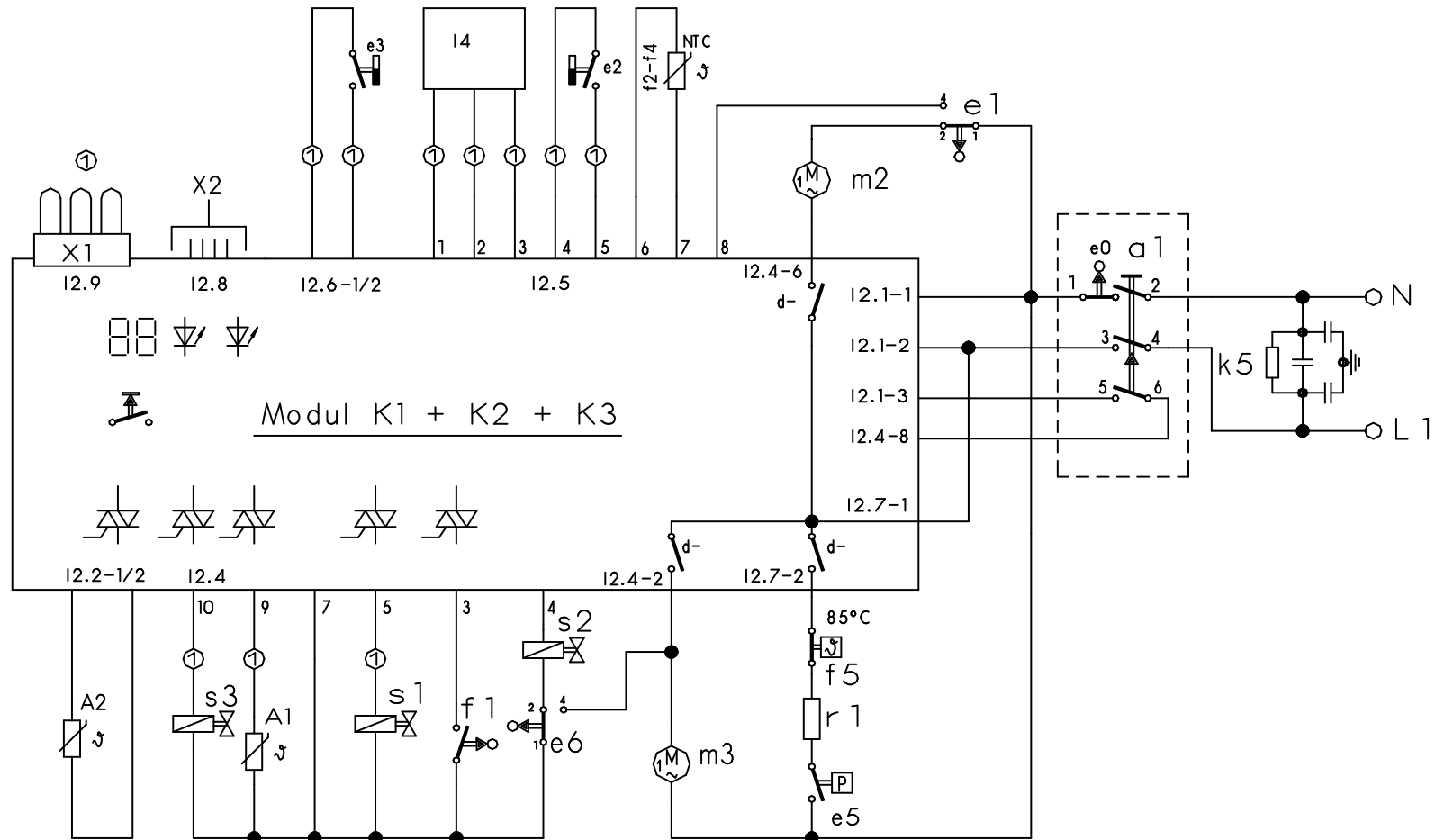

- | | | | | | |
|------|---|--------------------------|----|---|----------------------|
| a1 | = | main switch | m2 | = | circulation motor |
| e0 | = | door switch | m3 | = | drain motor |
| e1 | = | door switch | r1 | = | heating element |
| e2/3 | = | reed switch | e5 | = | pressure switch |
| e6 | = | float switch | s1 | = | regenerating valve |
| f1 | = | level switch | s2 | = | filling valve |
| NTC | = | temperature sensor | s3 | = | transfer valve |
| f5 | = | thermostat | A1 | = | actuator, upper base |
| k5 | = | interference suppression | A2 | = | actuator |
| k1 | = | display modul | l4 | = | aqua-sensor |
| k2 | = | control modul | x1 | = | code plug |
| k3 | = | time delay | x2 | = | service-connector |

① exit according to equipment



1 739 911 176

Ausg.: 10.97

S0-60/0356

Customer service test programme

Function	Temperature	Capacity	Time (s)	Sensor	Abbreviations
1	P		30		P = Pump
2	TR1 + TR2 till FD 7711				VF = Prefill / static
3	VF			F1	F = Fill / dynamic
4	F				U = Circulate
5	from FD 7712 U + H + TR1 + TR2				H = Heat
6	U + H + Z		120		Z = Dispenser
7	U + H	65 °C			R = Regenerate
8	U + H + R		120		D = Flush
9	P		60		A = Outlet (only by heat exchanger)
10	D + A		60		TR1+TR2 = Calibration of turbidity sensor
11	P + A		30		

To select the test programme press and hold the S2 and S4 buttons simultaneously and switch on the appliance.

The following displays are indicated on the control panel:

- LEDs L2 and L4 flash.
- As long as the two S2 and S4 buttons remain depressed after the dishwasher has been switched on, an identifier for the model coding is displayed when the overtravel contact has been successfully interrogated (e.g. 20 = Model 0, 21 = Model 1, etc.)
- By pressing one of the buttons, the associated LED lights up.
- By pressing the S3 button, the display and the “low level” indicator LEDs also light up.
- By pressing the time delay button, the Minutes LED lights up.

By pressing the S2 and S4 buttons, the test programme starts. Time delay programming is not possible, the test programme is ended by switching off the appliance via the main switch.

The potential fault code is displayed.

Fault code	Two 7-segment displays
0	There is no fault
1	Fault in the hydro sensor system Note: Display even if there is no sensor!
2	Heater fault
3	Fault combination Fault 1 + Fault 2
4	Filling fault
5	Fault combination Fault 1 + Fault 4
8	Fault in NTC system
9	Fault combination Fault 1 + Fault 8
10	Fault combination Fault 2 + Fault 8
F	Filling fault (is only displayed from FD7711)

The upper basket function is activated during the whole test program. The next programme step can be selected by pressing the S3 button; if the heater step is skipped, a heater fault is displayed. (Exception: Select the filling step with the F1 filling switch only).

Fault code display is in the customer service test programme only!

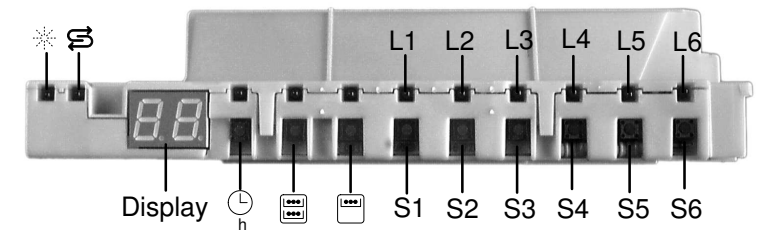
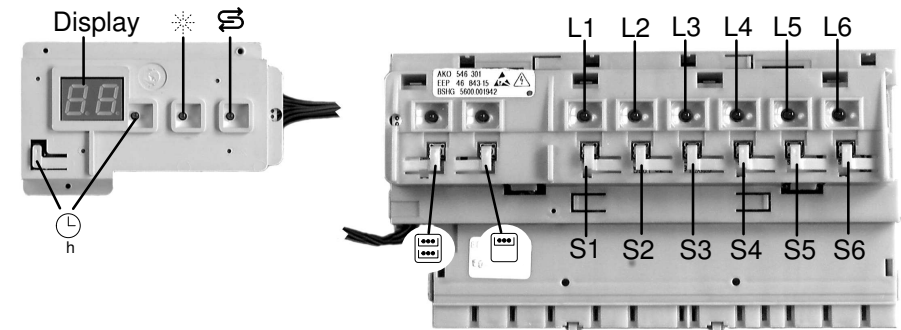

1 739 911 152	Issued: 09.00
	S0-60/0343