

Hauptschalter

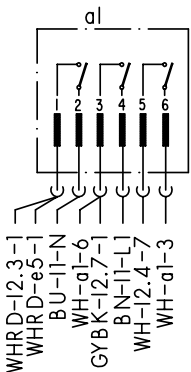

Zugabe

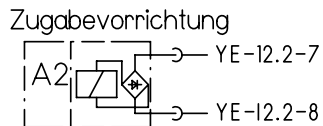

Zeitvorwahl, Bedien- u. Steuermodul

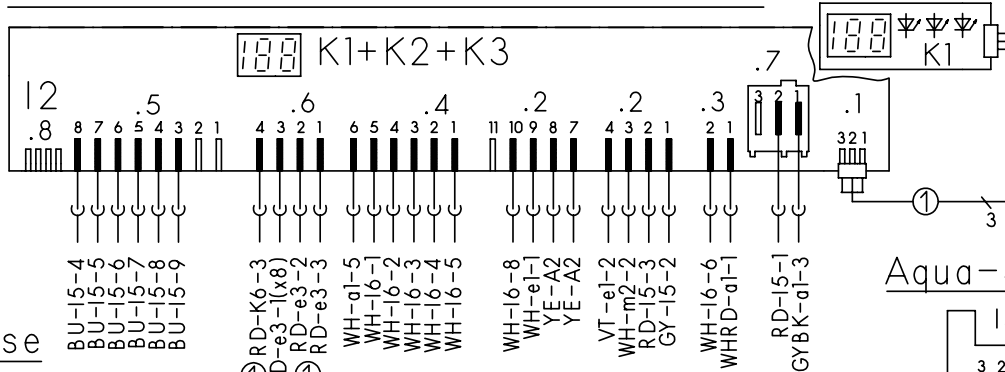

Sensoren

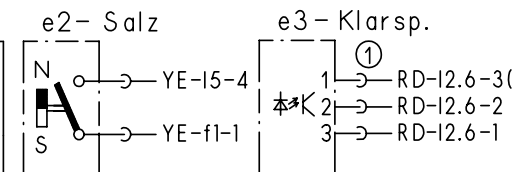

Niveaudruckdose

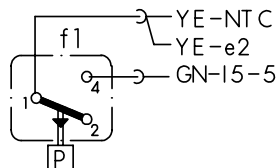

Temp.-regler + NTC

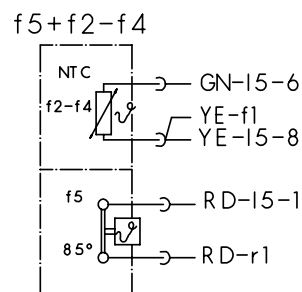

Schutzleiter

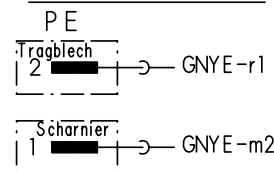

Aqua-Sensor

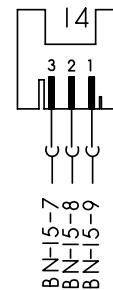

Splice ①

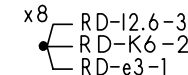

Kupplung

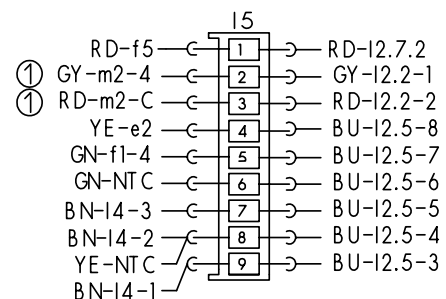
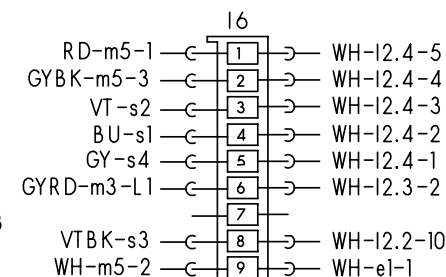

Türschalter

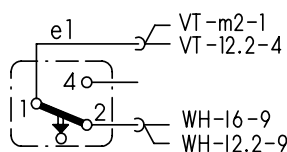

Magnetventile

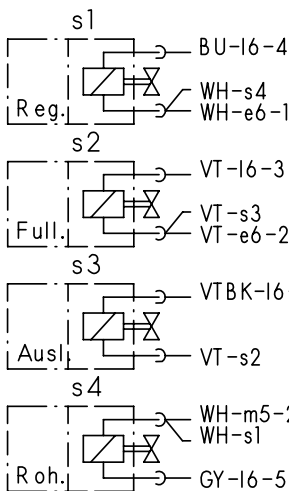

Schwimmersch.

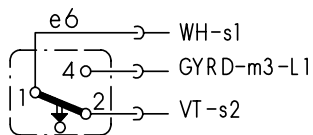

Anlass-PTC

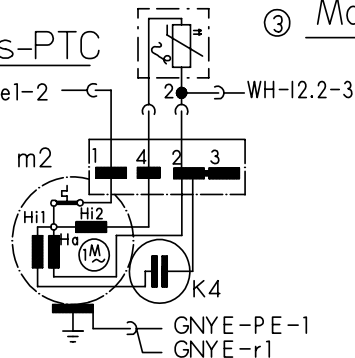

Motor ③

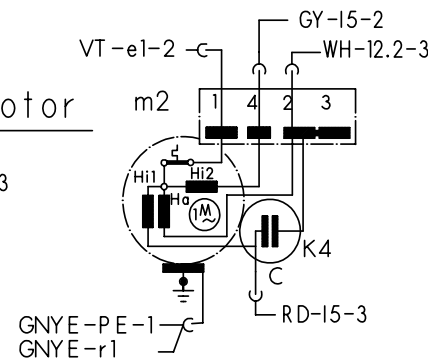

Wasserweiche

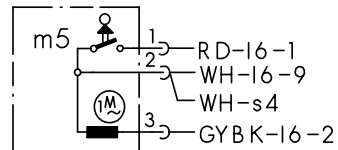

Klemme I1 mit Entstoerung

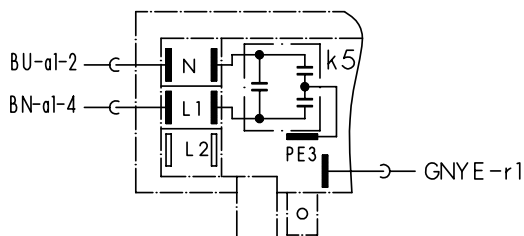

Info-Light ①

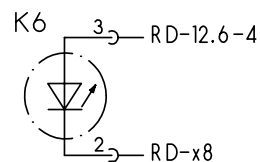

Heizung

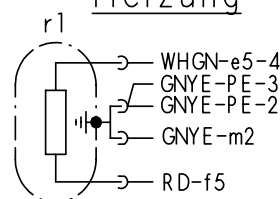

Sicherheitssch.

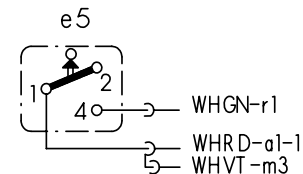

Laugenpumpe

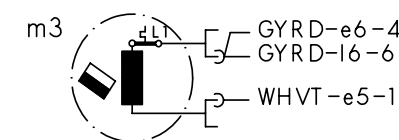

③ je nach Motortyp

① je nach Ausstattung vorhanden

② wenn vorhanden ohne Funktion



Mat.Nr.: 9000009361	
Ausg.: 02.04	S0-60/0812

Model coding

1. Selecting the model coding:

When the door is open, hold down two buttons and press main switch until the model coding is indicated on the display.

2. Select special programme:

When the two buttons are released, LED L3 lights up and LED L4 flashes. P0 is displayed. Select the required special programme by pressing the S3 button. Keep pressing S3 until P4 is displayed.

Press S4 to acknowledge the selected programme

3. Set the model:

The different codings can be set according to the programme symbols (see table) by pressing the S3 button.

4. Save model:

The new coding is saved by switching off the appliance

Code table:

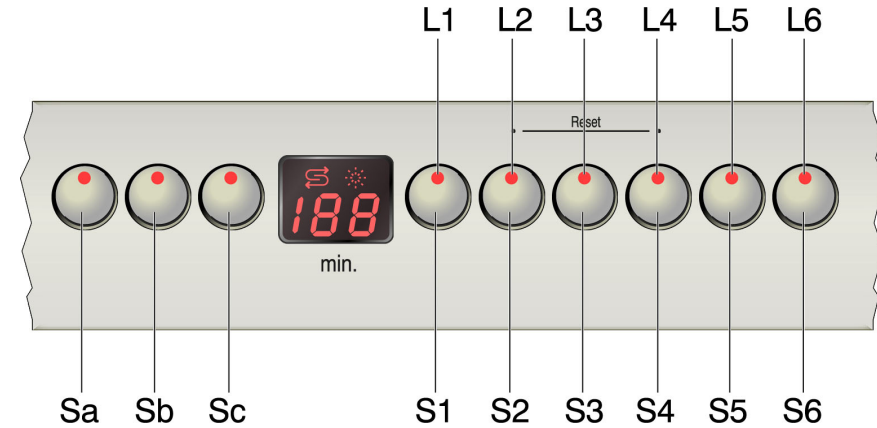

SA	SB	SC	S1	S2	S3	S4	S5	S6	Display
Soak	Reduce time	Timer programming	Intensive	Auto	ECO	Gentle	Quick	Prerinse	C1
Soak	Reduce time	Timer programming	Intensive	Auto	ECO	Quick	Prerinse		C2
Top basket	Bottom basket	Timer programming	Intensive	Auto	ECO	Gentle	Quick	Prerinse	C3



auto



9 000 011 965	Ausg.: 03.04
GV636 V	S0-60/0870

Intensive 70° Auto 55°/ 65° ECO 50° Gentle Quick Prerinse Soak Bottom basket Top basket (TB) Timer programming (TP)

9 000 011 965	Ausg.: 03.04
GV636 V	S0-60/0870