

Zeitvorwahl+ Bedienmodul

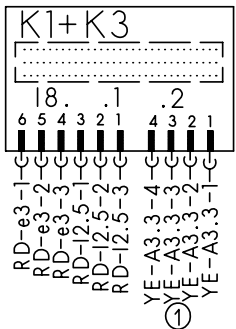

Hauptschalter

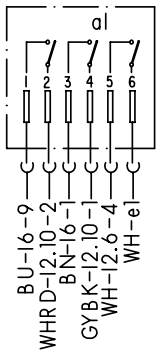

Steuermodul

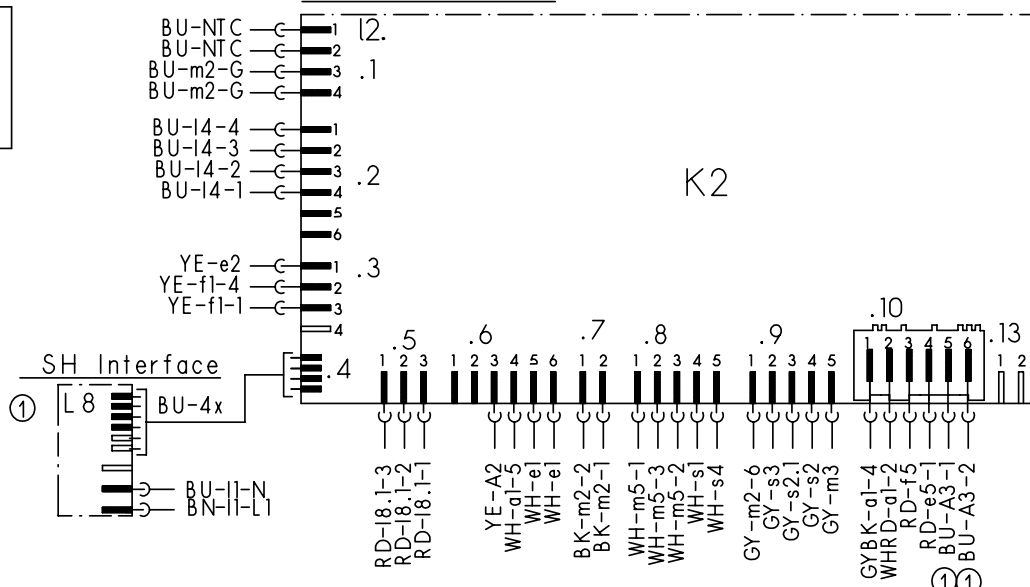

Sensoren

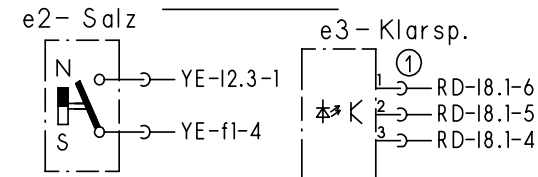

Aqua-Sensor

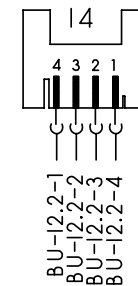

Schutzleiter

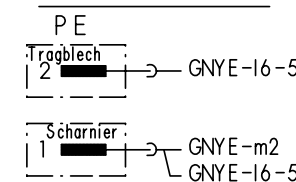

Türschalter

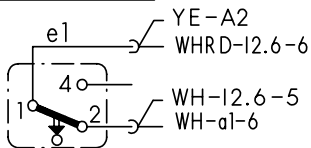

Optosensor

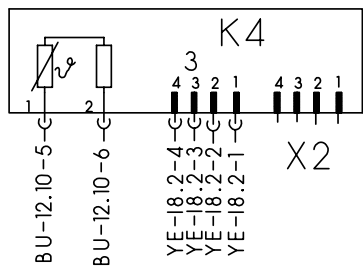

Magnetventile

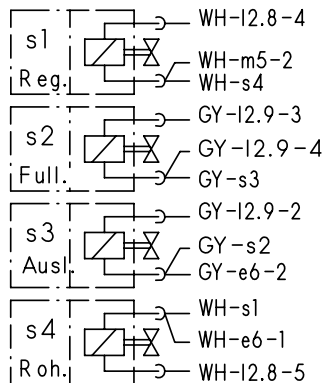

Temperaturregler+NTC

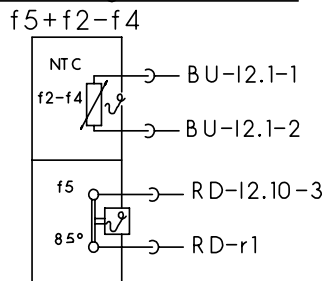

Heizung

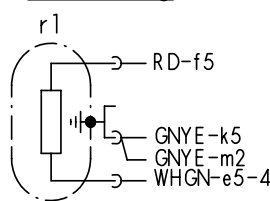

Aktuator Zugabevorrichtung

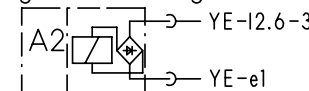

Wasserweiche

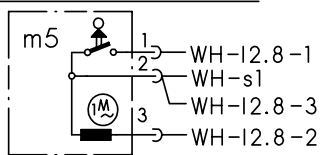

Schwimmersch.

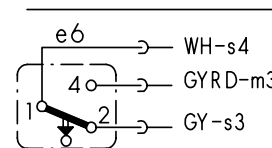

Anlaufrelais

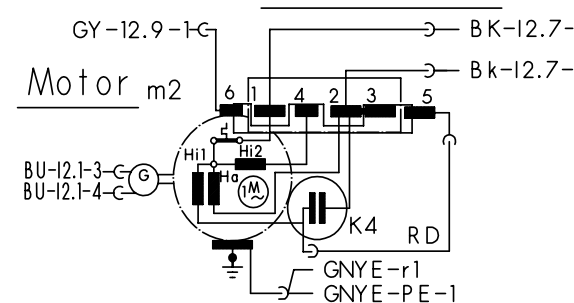

Sicherheitssch.

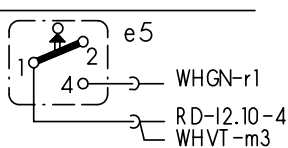

Klemme I1

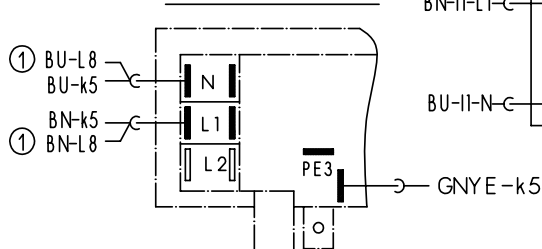

Entstoerung

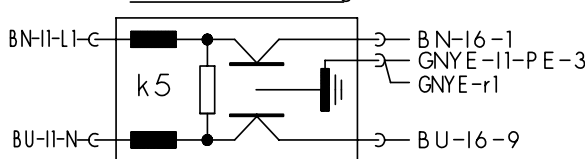

Laugenpumpe

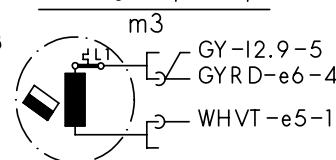

Niveaudruckdose

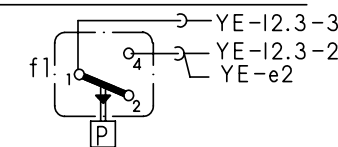

Mat.Nr.: 5600058773	
Ausg.: 06.03	SO-60/ 0783

(1) je nach Ausstattung vorhanden

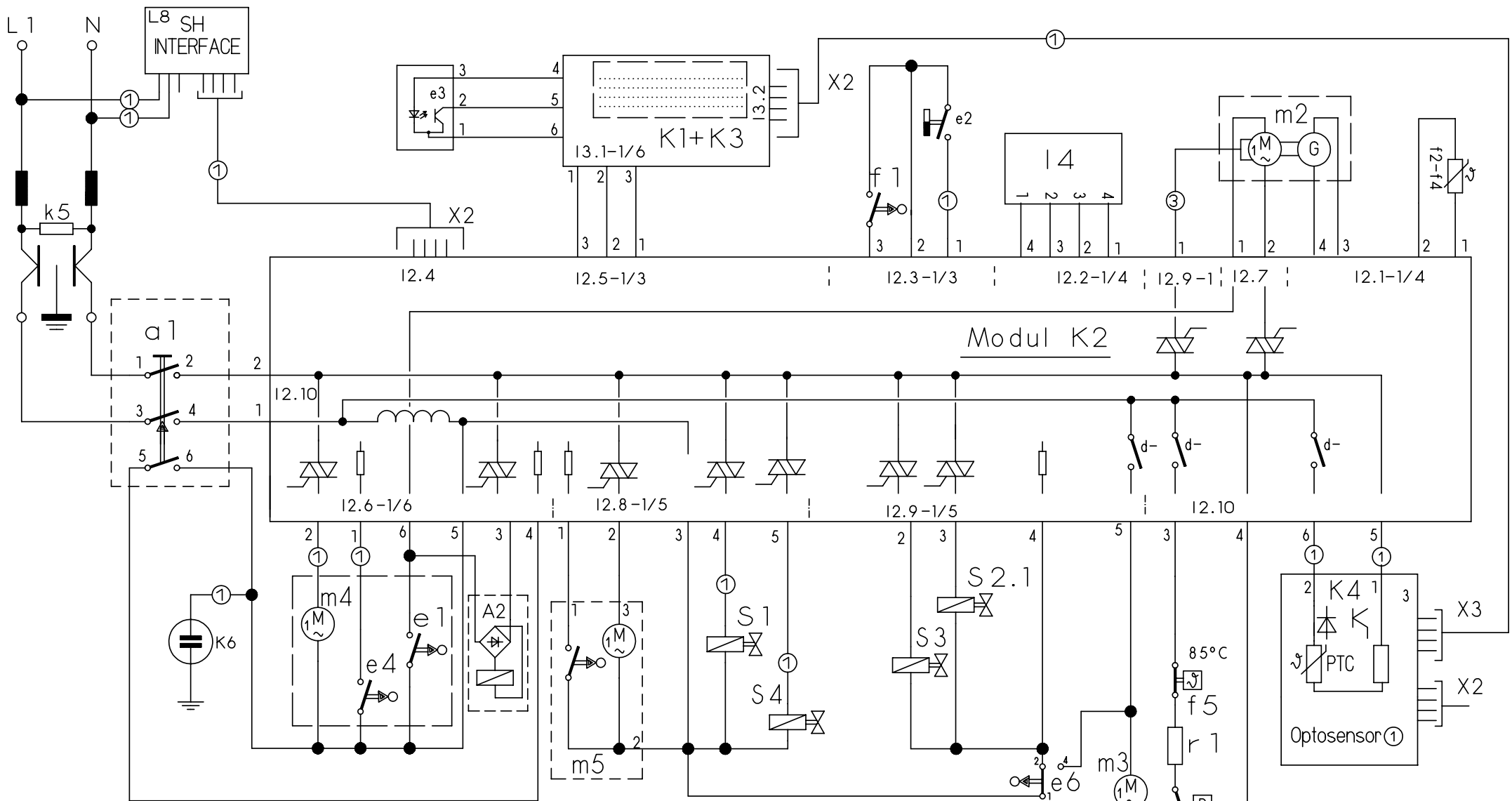

- | | | | | | | | | |
|------|---|--------------------------|----|---|-------------------|----|---|-------------------|
| a1 | = | Hauptschalter | m2 | = | Umwälzpumpe | m4 | = | Motor-Tuerschloss |
| e1 | = | Tuerschalter | m3 | = | Pumpe entleeren | e4 | = | Positionsschalter |
| e2/3 | = | Sensor/Salz/Klarsp. | r1 | = | Heizung | m5 | = | Wasserweiche |
| e6 | = | Schwimmerschalter | s1 | = | Regenerierventil | L4 | = | Aqua-Sensor |
| f1 | = | Wasserstandsregler | s2 | = | Fuellventil | k6 | = | Entstoerung |
| NTC | = | Temperatursensor | s3 | = | Auslassventil | s4 | = | Rohwasserventil |
| f5 | = | Temperaturregler | A2 | = | Zugabe-Aktuator | L8 | = | SH Inerface |
| k5 | = | Entstoerung | x2 | = | Service-Anschluss | | | |
| K1 | = | Anzeige - u. Bedienmodul | | | | | | |
| K2 | = | Steuerungsmodul | | | | | | |
| K3 | = | Zeitvorwahl | | | | | | |
| K4 | = | Optosensor | | | | | | |

① je nach Ausstattung

③ Anlaufrelais



Mat. Nr. 5600058772	
Ausg.: 06.03	S0-60/0782