

4349178

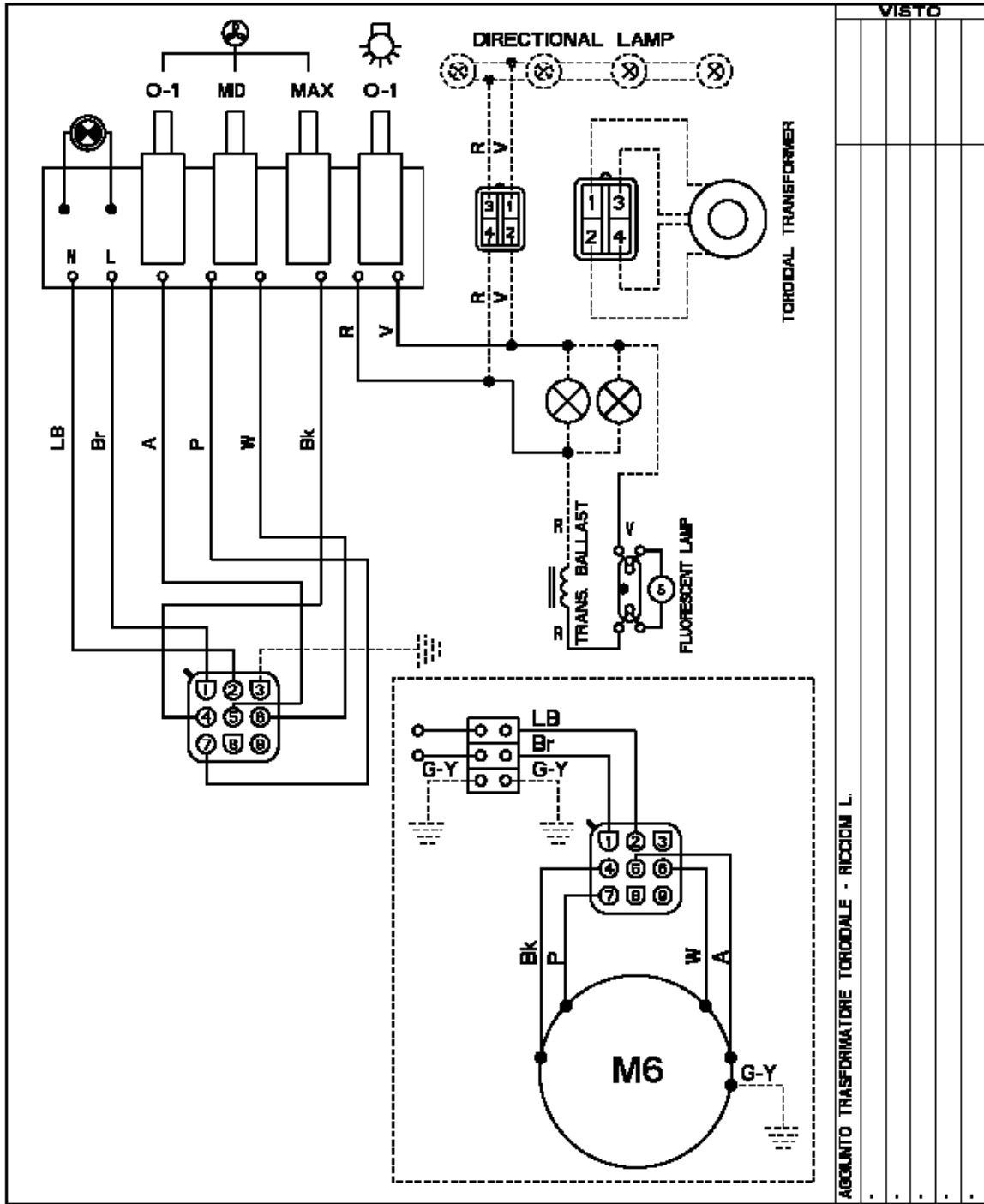

4349183