

N

 Strom-
 pfad

1 2 3 4 5 6 7

10 11 12 13 14 15 16 17

- d 1 = PTC-Glied
- e 1 = Schutzschalter
- e 2 = Schalter "Gluehlampe"
- f 1 = Poti m. Schalter
- f 2 = Elektronik
- h 1 = Gluehlampe
- l 1 = Anschlussteil
- l 2 = Tragschiene
- l 3 = Steckergehaeuse (6pol.)
- l 5 = Randsteckergehaeuse (7pol.)
- l 7 = Steckbuchse
- l 8 = Steckgehaeuse (5pol.)
- l 9 = Steckergehaeuse (5pol.)
- l 10 = Steckgehaeuse (5pol.)
- l 11 = Steckergehaeuse (5pol.)
- m 1 = Verdichtermotor
- m 2 = Ventilatormotor
- r 1 = Temp.-Fuehler 10°C
- r 2 = Temp.-Fuehler 0°C
- s 1 = 3 - Wege - Ventil

Strom-
 pfad
 11 / 13
 13
 17
 1 / 2
 3 - 15
 17

11 / 13
 14
 6
 4
 15



1 709 911 557	08 / 93
	50/171

d1 PTC-Glied

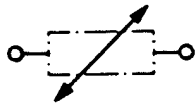

e1 Schutzschalter



e2 Schalter "Gluehlampe"



f1 Poti mit Schalter

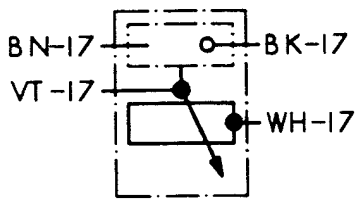

f2 Elektronik + 13+15

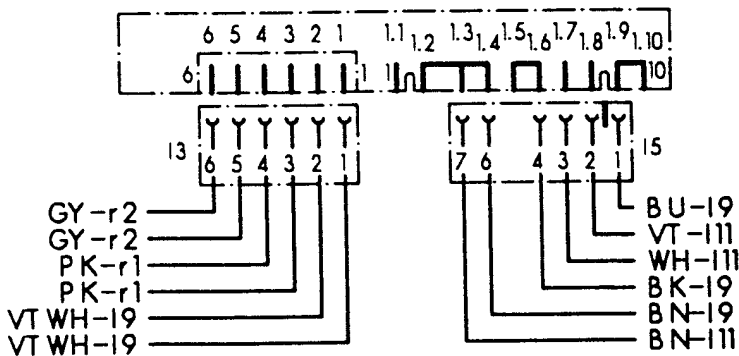

h1 Gluehlampe

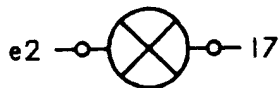

k1 Betriebskondensator

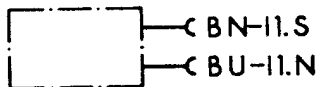

Farbe	Kurzzeichen nach DIN/IEC 757
schwarz	BK
braun	BN
rot	RD
orange	OG
gelb	YE
gruen	GN
blau	BU
violett	VT
grau	GY
weiss	WH
rose	PK
gold	GD
tuerkis	TO
silber	SR

11 Anschlusssteil (DANFOSS)

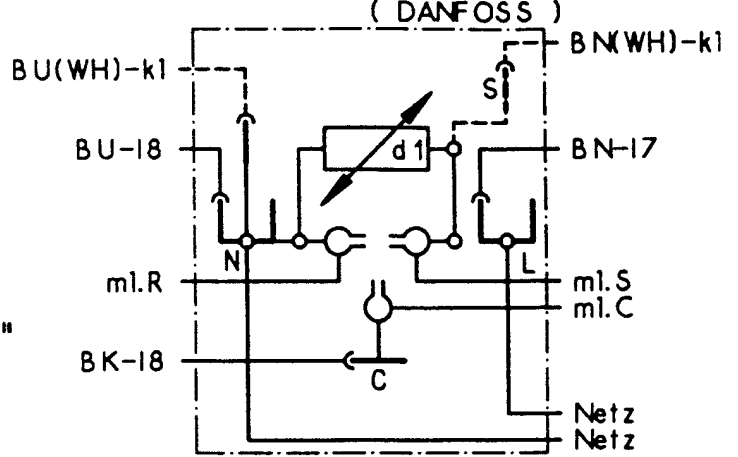

12 Tragschiene

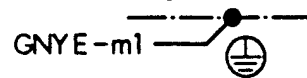

17 Steckbuchse

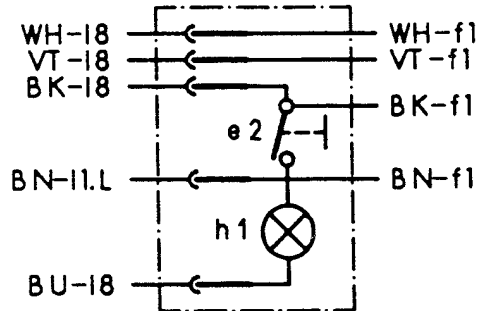

18 Steckgehaeuse + 19 Steckergehaeuse

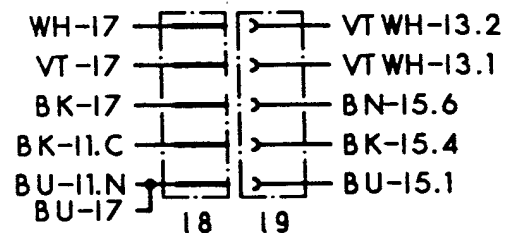

110 Steckgehaeuse + 111 Steckergehaeuse

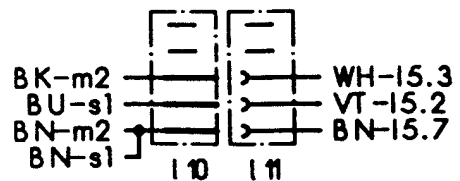

1 709 911 557	07 / 93
(D)	50/172

m1 Verdichter-Motor

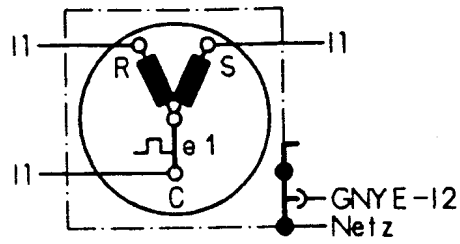

m2 Ventilator-Motor



r1 Temperaturfuehler 10°C

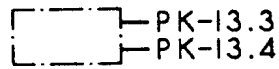

r2 Temperaturfuehler 0°C

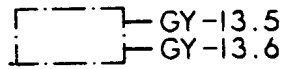

s1 3-Wege-Ventil

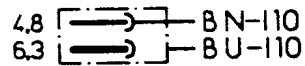

Farbe	Kurzzeichen nach DIN/IEC 757
schwarz	BK
braun	BN
rot	RD
orange	OG
gelb	YE
gruen	GN
blau	BU
violett	VT
grau	GY
weiss	WH
rosa	PK
gold	GD
luerkis	TQ
silber	SR

ⓓ

1 709 911 557	07 / 93
	50/173

Sollkurvennr. 58

HWG - EGV

11:38 28. 7.95

Geraete-Typ: KS KIF24MS TLES9K

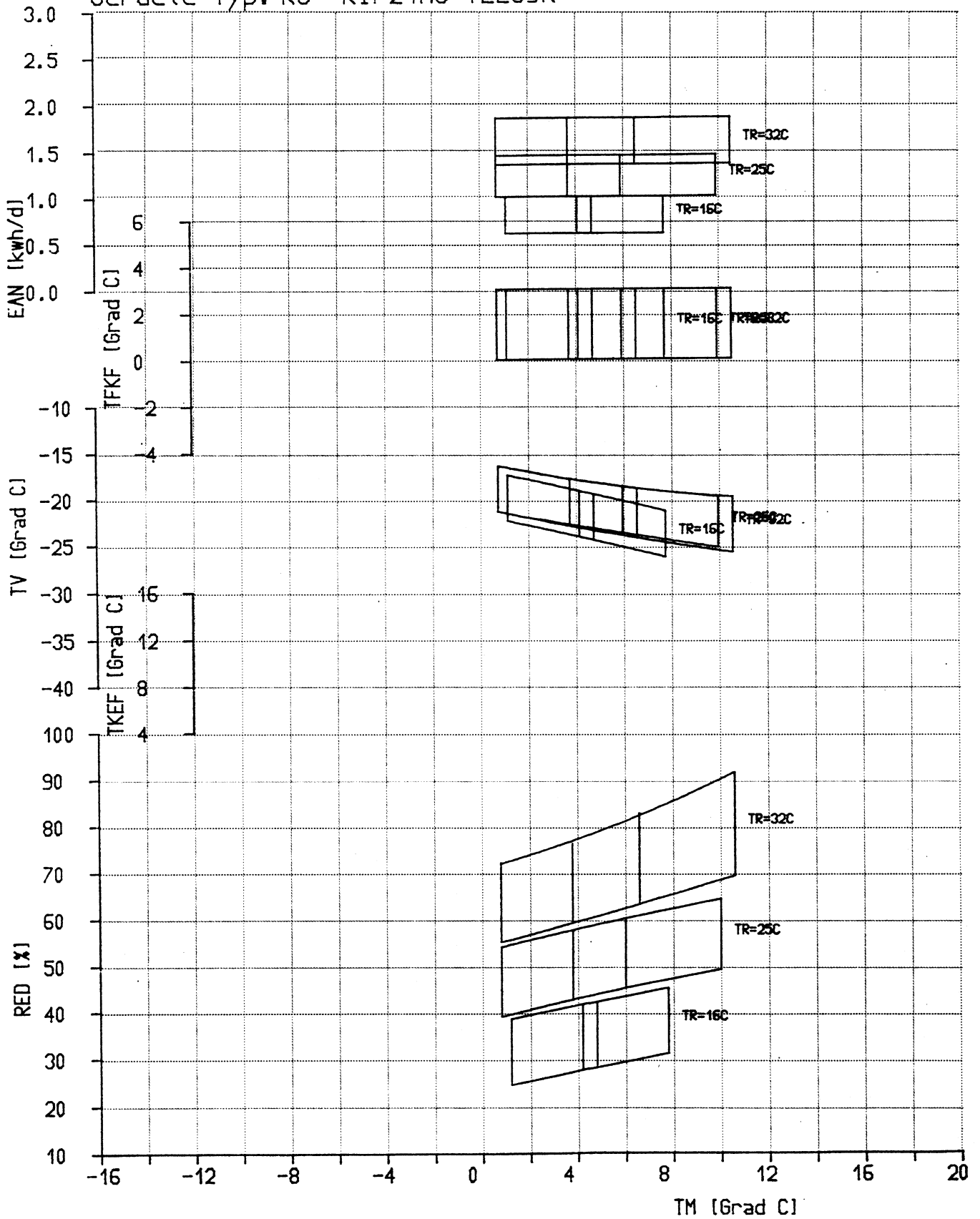

D

KIF24MS	Ausg.: 09.95
1.709.918.392	s0-50/0375D