

Strom-
pfad

1

2

3

4

5

6

7

8

Strom-
pfad

4

1/2

2

5

7

4-7

1/2

4

6

5

7

1/2

1/2

3

8

- a 1 = Hauptschalter
- d 1 = PTC-Glied
- e 1 = Schutzschalter
- e 2 = Schalter "super"
- e 3 = Schalter "Alarm"
- e 4 = Schaltpult
- f 1 = Temperaturregler
- h 1 = Kontrolllampe "Netzanzeige" (gruen)
- h 2 = Kontrolllampe "alarm" (rot)
- h 3 = Kontrolllampe "super" (gelb)
- h 4 = Summer
- k 1 = Betriebskondensator
- l 1 = Anschlussteil
- l 2 = Tragschiene
- l 3 = Steckgehaeuse
- m 1 = Verdichter-Motor
- m 2 = Ventilator-Motor
- r 1 = Rahmen-Heizung

D

1 709 911 570	Ausg.: 02.94
	S0-50/0193

a1 Hauptschalter



d1 PTC-Glied

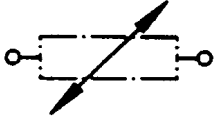

e1 Schutzschalter



I3 Steckgehäuse
+ e4 Schaltpult

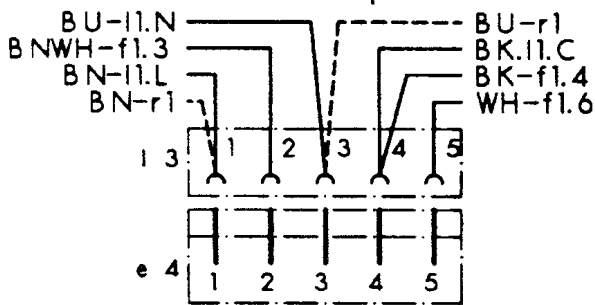

f1 Temperaturregler

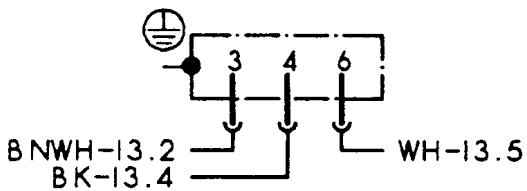

k1 Betriebskondensator

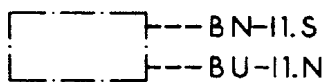

I1 Anschlussteil

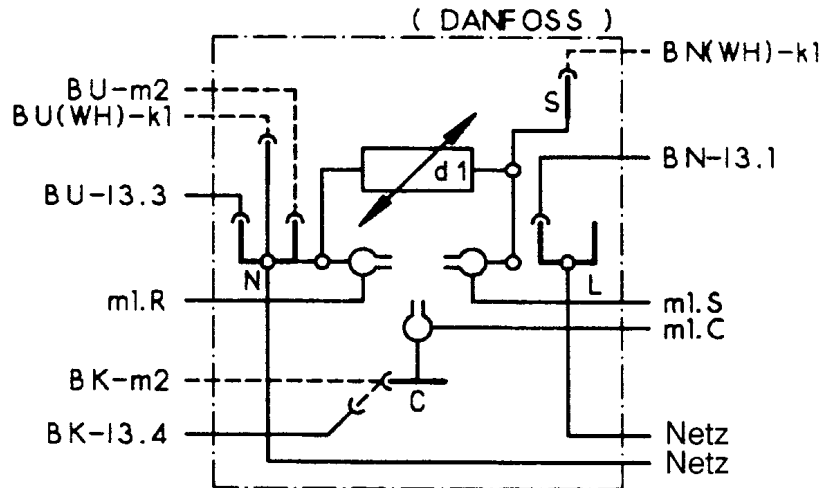

I2 Tragschiene

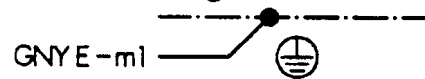

m1 Verdichter-Motor

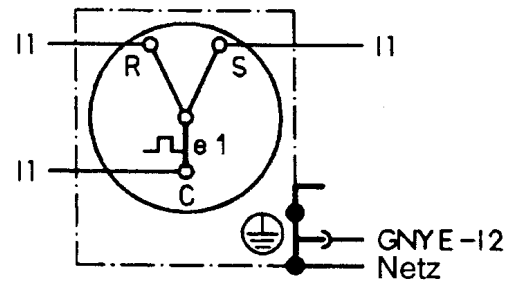

m2 Ventilator-Motor



r1 Rahmenheizung

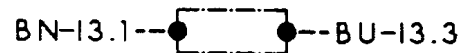

(D)

1 709 911 570	Ausg.: 02.94
	S0-50/0194

Sollkurvennr. 201

HWG - EGV

9:56 28. 7.95

Geraete-Typ: GS GIL1035TLES7K D86

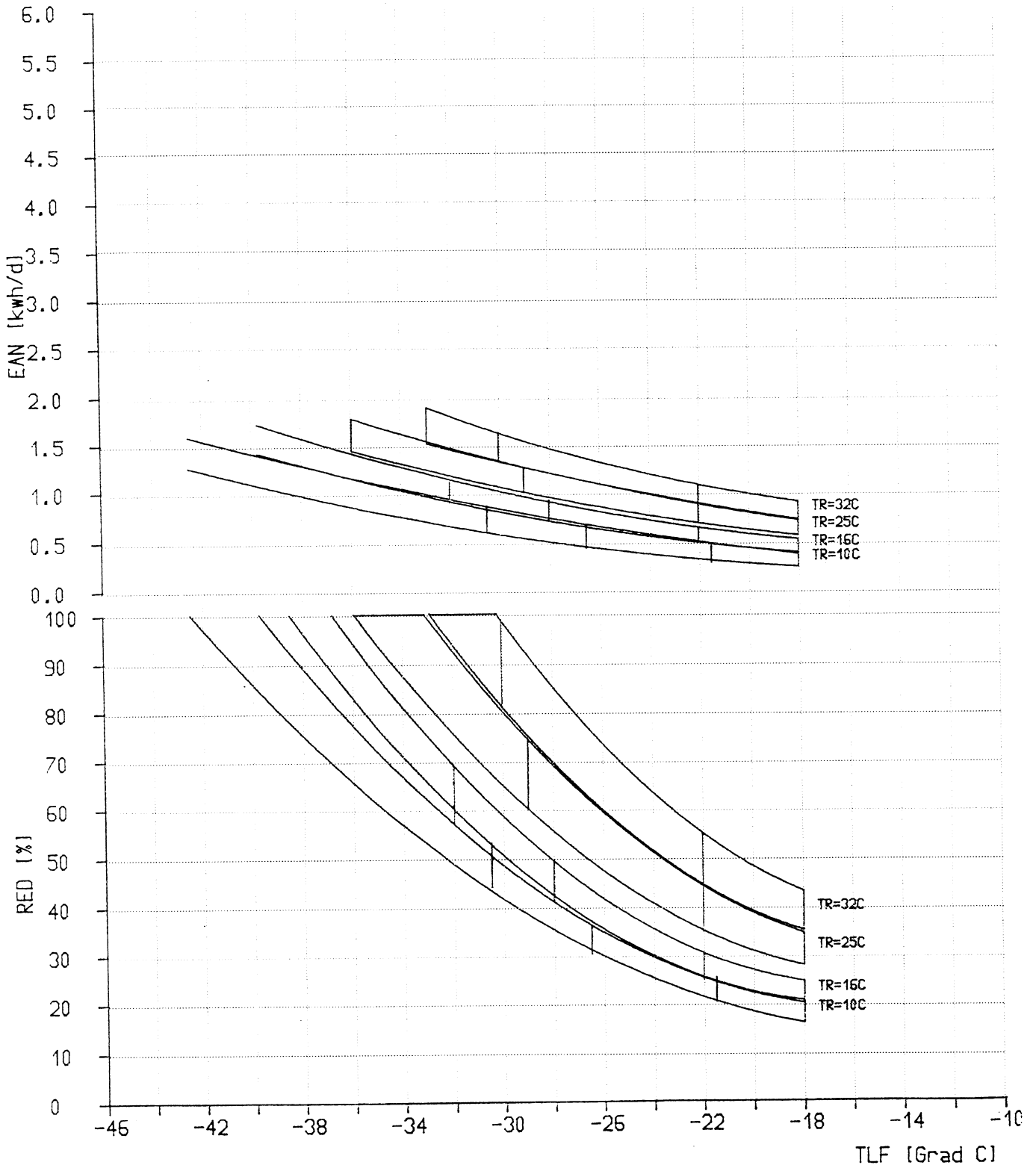

D

1.7.10-4

GIL1035	Ausg.: 09.95
1.709.918.390	s0-50/0371D