

Strom-
pfad

1

2

3

4

5

6

7

8

Strom-
pfad

4.

1 / 2.

2.

5.

7.

4 - 7.

1 / 2.

4.

6.

5.

7.

1 / 2.

1 / 2.

3.

8.

- a 1 = Hauptschalter
- d 1 = PTC-Glied
- e 1 = Schutzschalter
- e 2 = Schalter "super"
- e 3 = Schalter "Alarm"
- e 4 = Schaltpult
- f 1 = Temperaturregler
- h 1 = Kontrollampe "Netzanzeige" (gruen)
- h 2 = Kontrollampe "alarm" (rot)
- h 3 = Kontrollampe "super" (gelb)
- h 4 = Summer
- k 1 = Betriebskondensator
- l 1 = Anschlussteil
- l 2 = Tragschiene
- l 3 = Steckgehaeuse
- m 1 = Verdichter-Motor
- m 2 = Ventilator-Motor
- r 1 = Rahmen-Heizung

(D)

1 709 911 665	04 / 99
.	.S0-50/0848

a1 Hauptschalter

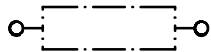

d1 PTC-Glied

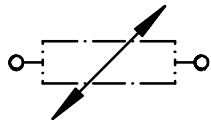

e1 Schutzschalter



l3 Steckgehaeuse
+ e4 Schaltput

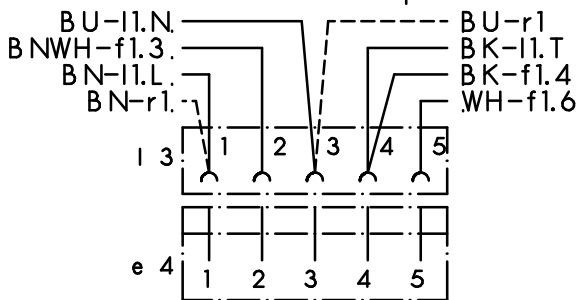

f1 Temperaturregler

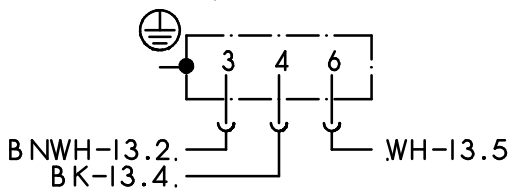

k1 Betriebskondensator

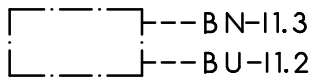

l1 Anschlussteil

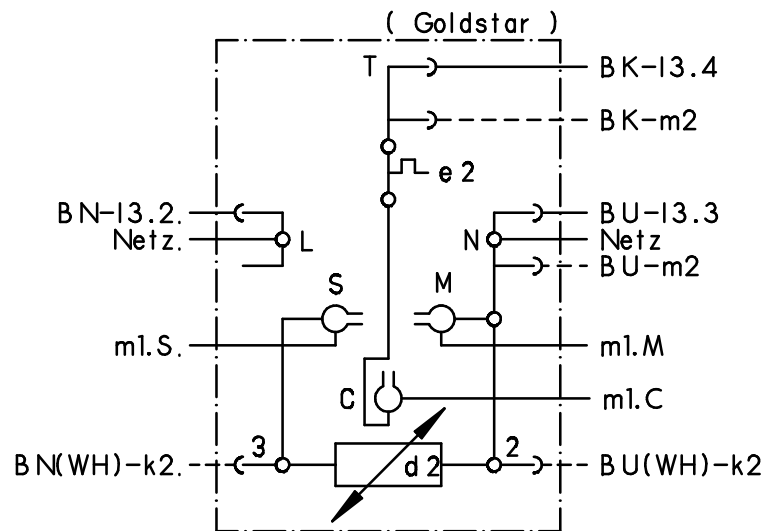

l2 Tragschiene

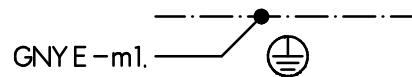

m1 Verdichter-Motor

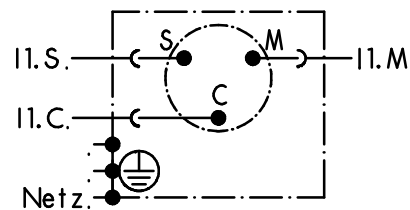

m2 Ventilator-Motor



r1 Rahmenheizung



Farbe	Kurzzeichen nach DIN/IEC 757
schwarz	BK
braun	BN
rot	RD
orange	OG
gelb	YE
gruen	GN
blau	BU
violett	VT
grau	GY
weiss	WH
rosa	PK
gold	GD
tuerkis	TQ
silber	SR



1 709 911 665	04 / 99
.	.S0-50/0849