

current path 1 2 3 4 5 6 7 8

- a 1 = main switch
- d 1 = PTC resistor
- e 1 = protection switch
- e 2 = switch "super"
- e 3 = switch "alarm"
- e 4 = control panel
- f 1 = thermostat
- h 1 = pilot lamp "mains" (green)
- h 2 = pilot lamp "alarm" (red)
- h 3 = pilot lamp "super" (yellow)
- h 4 = buzzer
- k 1 = motor operating capacitor
- l 1 = terminal block
- l 2 = bearing rail
- l 3 = plug connector
- m 1 = compressor
- m 2 = condenser motor
- r 1 = frame heater

- current path
- 4.
- 1 / 2.
- 2.
- 5.
- 7.
- 4 - 7.
- 1 / 2.
- 4.
- 6.
- 5.
- 7.
- 1 / 2.
- 1 / 2.
- 3.
- 8.

GB

1 709 911 665	04 / 99
.	.S0-50/0848

a1 main switch



d1 PTC resistor

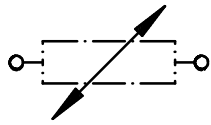

e1 protection switch

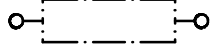

l3 plug connector
+ e4 control panel

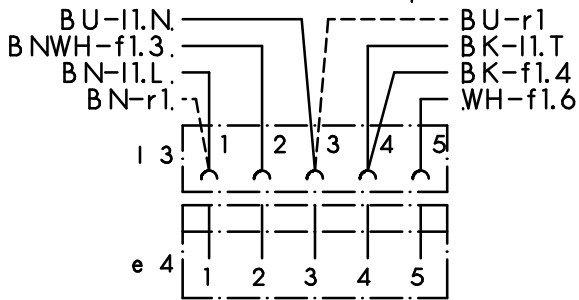

f1 thermostat

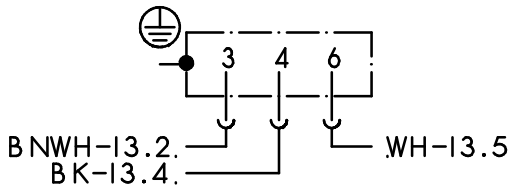

k1 motor operating capacitor

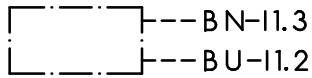

l1 terminal block

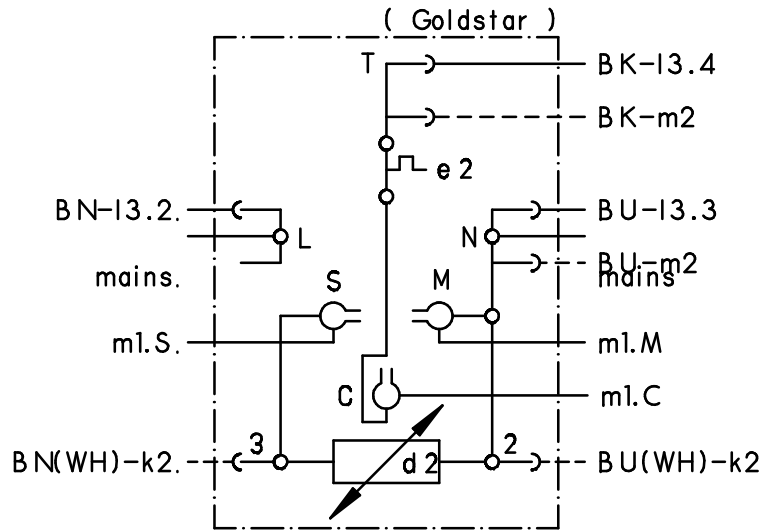

l2 bearing rail

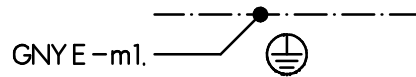

m1 compressor

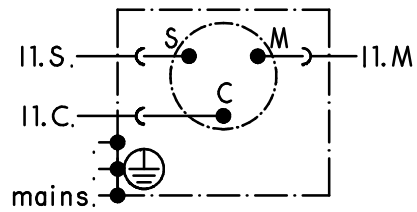

m2 condensor motor



r1 frame heater

